

06040800 - TH-CUT D40 UT1-1/4" (32) MS

Tipo	TH-CUT Portautensili statico portalama
Attacco	CILINDRICO 40
Uscita utensile	TH porta lama 1-1/4"(32)
Raffreddamento	Refrigerazione esterna
H [mm]	80

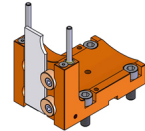

Accessori	N.D.
Note	N.D.
Note per il montaggio	N.D.

Verificare sempre gli ingombri del portautensile in torretta

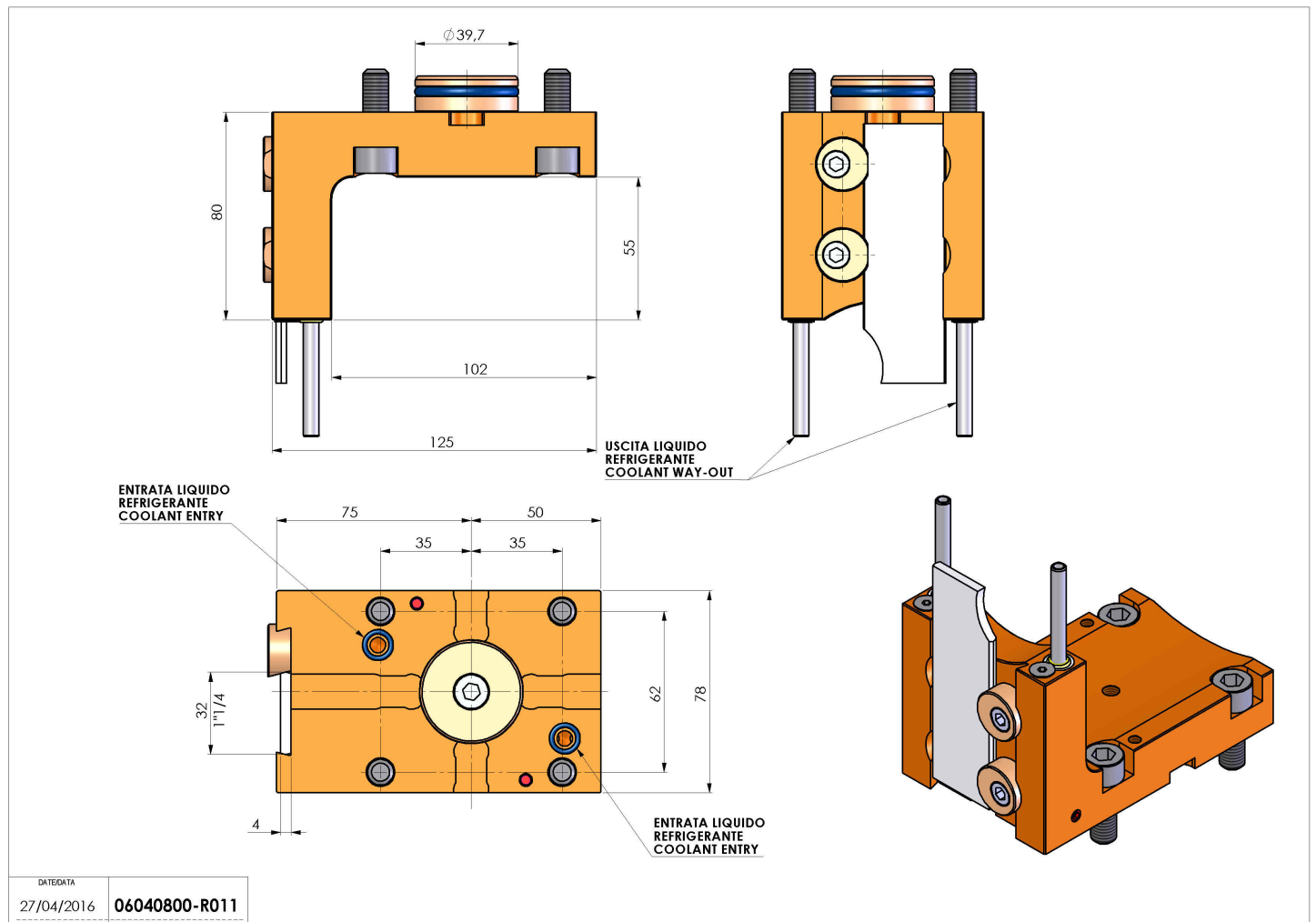

DATE/DATE	27/04/2016
PART NUMBER	06040800-R011

Salvo modifiche tecniche