



05401300 - LT-S D60 WELDON25 RF H119

Tipo	LT-S Portautensili dritto
Attacco	CILINDRICO 60
Uscita utensile	Weldon 25 DIN1835B
Raffreddamento	Refrigerazione interna
Senso di rotazione	r1  r2 
Velocità max [1/min]	6000
Coppia max [Nm]	63
Rapporto	1:1
H [mm]	119
Pressione max [bar]	20
Accessori	N.D.
Note	N.D.
Note per il montaggio	N.D.



Verificare sempre gli ingombri del portautensile in torretta

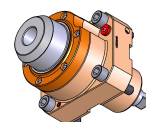
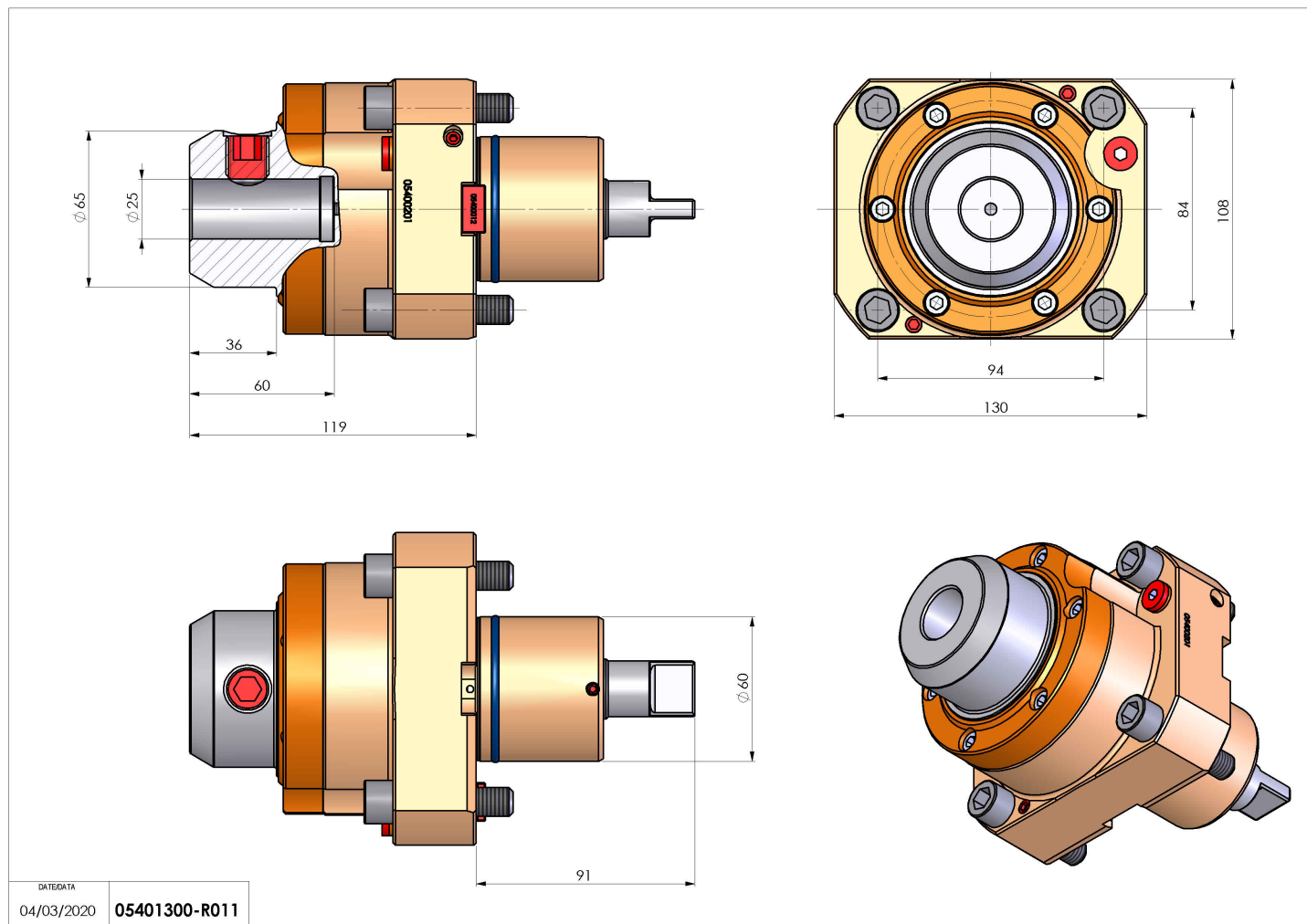

Salvo modifiche tecniche

DATE/DATE
04/03/2020 05401300-R011