

05385300 - LT-S D65 ER25F RF H69

Tipo	LT-S Portautensili dritto
Attacco	CILINDRICO 65
Uscita utensile	Portapinza ER 25 F - ghiera interna
Raffreddamento	Refrigerazione interna
Senso di rotazione	r1 r2
Velocità max [1/min]	6000
Coppia max [Nm]	70
Rapporto	1:1
H [mm]	69
Pressione max [bar]	20
Accessori	N.D.
Note	N.D.
Note per il montaggio	N.D.

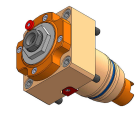

Verificare sempre gli ingombri del portautensile in torretta

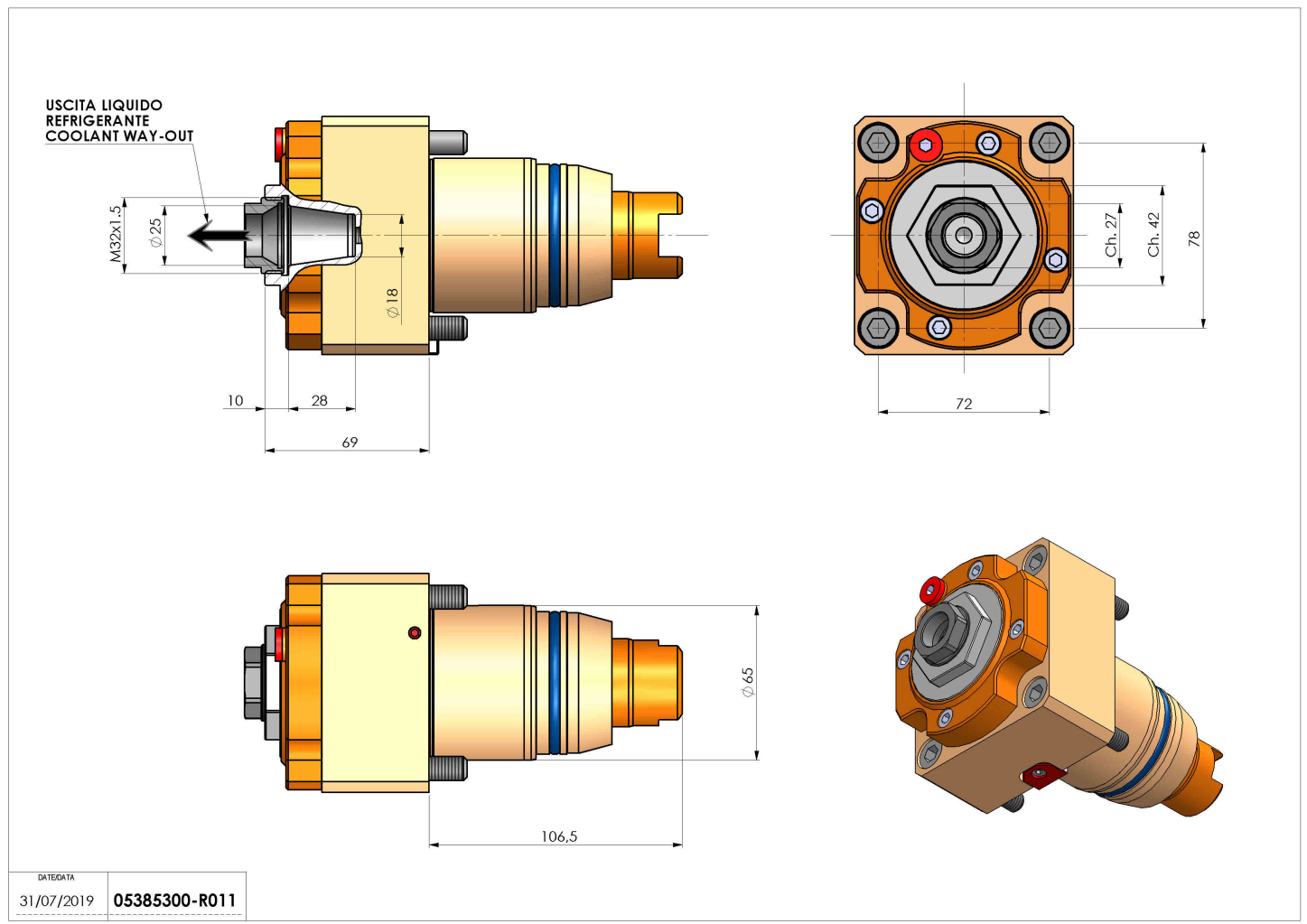

DATE/DATE	
31/07/2019	05385300-R011

Salvo modifiche tecniche