



05385200 - LT-S D65 ER32F H69

Tipo	LT-S Portautensili dritto
Attacco	CILINDRICO 65
Uscita utensile	Portapinza ER 32 F - ghiera interna
Raffreddamento	Refrigerazione esterna
Senso di rotazione	r1  r2 
Velocità max [1/min]	6000
Coppia max [Nm]	70
Rapporto	1:1
H [mm]	69
Accessori	N.D.
Note	N.D.
Note per il montaggio	N.D.



Verificare sempre gli ingombri del portautensile in torretta

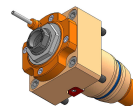
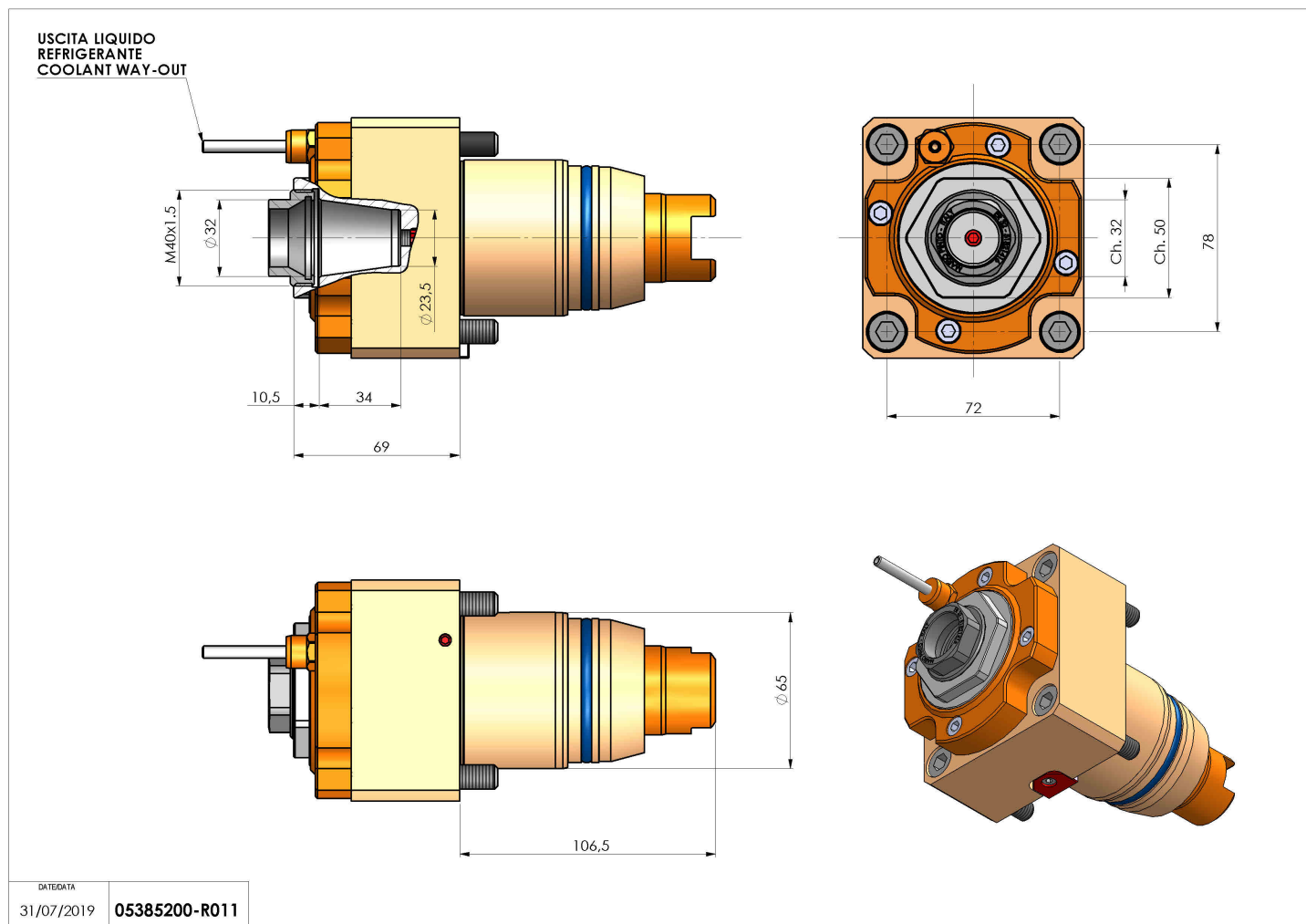

Salvo modifiche tecniche