



05328900 - LT-A BMT55 ER32F LR HRF H60

Tipo	LT-A Portautensili angolare a 90°
Attacco	BMT 55
Uscita utensile	Portapinza ER 32 F - ghiera interna
Raffreddamento	Refrigerazione interna HRF
Senso di rotazione	r1  r2 
Velocità max [1/min]	6000
Coppia max [Nm]	40
Rapporto	1:1
H [mm]	60
H1 [mm]	32.5
Pressione max [bar]	80
Accessori	N.D.
Note	N.D.
Note per il montaggio	N.D.



Verificare sempre gli ingombri del portautensile in torretta

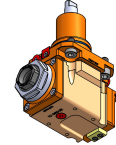
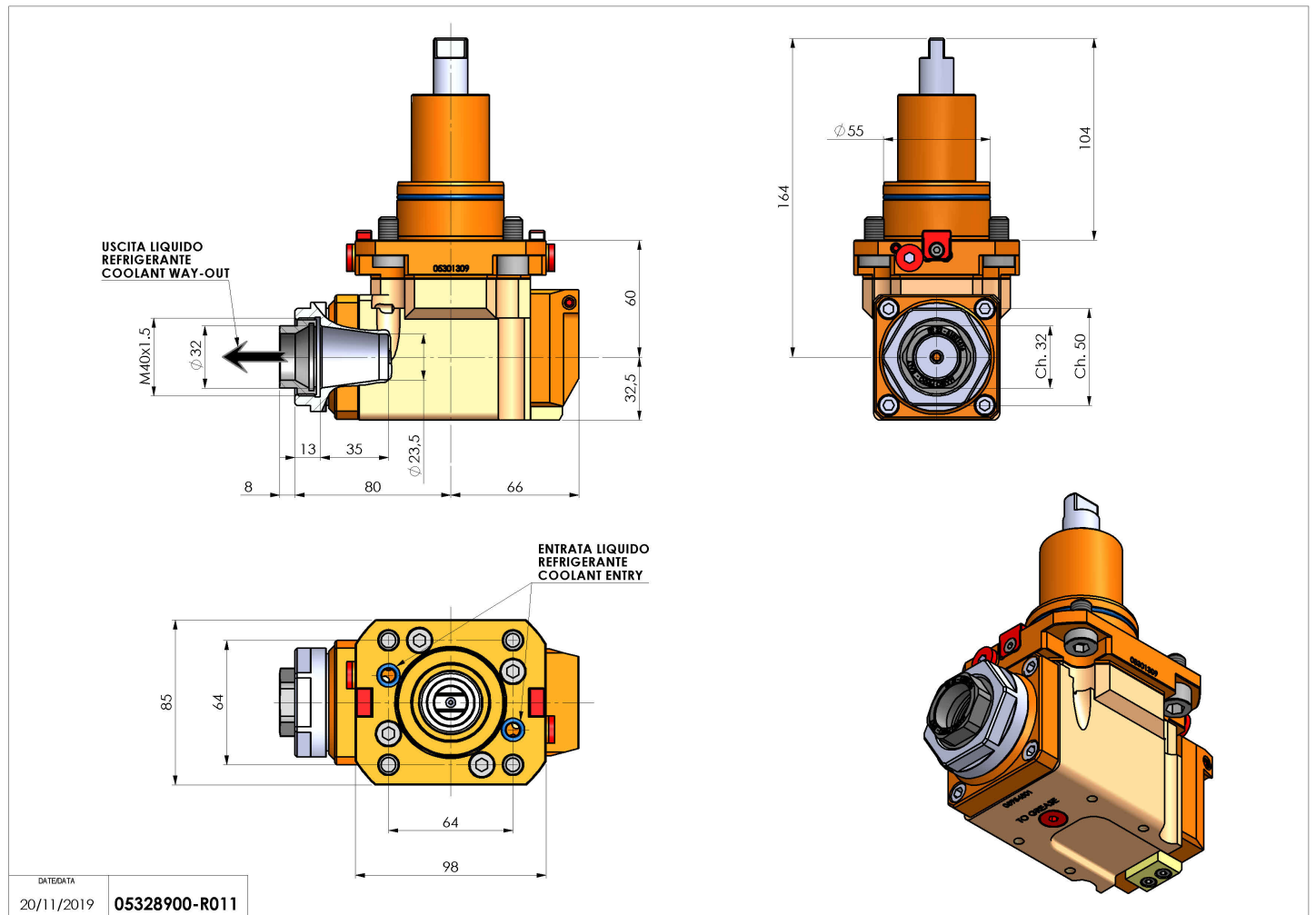

DATE/DATE
20/11/2019 **05328900-R011**

Salvo modifiche tecniche