

05311400 - LT-S BMT55 BD ER32F RF H65

Tipo	LT-S Portautensili dritto
Attacco	BMT 55 BIG DRIVE
Uscita utensile	Portapinza ER 32 F - ghiera interna
Raffreddamento	Refrigerazione interna
Senso di rotazione	r1 r2
Velocità max [1/min]	6000
Coppia max [Nm]	60
Rapporto	1:1
H [mm]	65
Pressione max [bar]	20
Accessori	N.D.
Note	N.D.
Note per il montaggio	N.D.

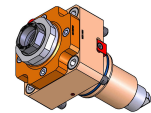

Verificare sempre gli ingombri del portautensile in torretta

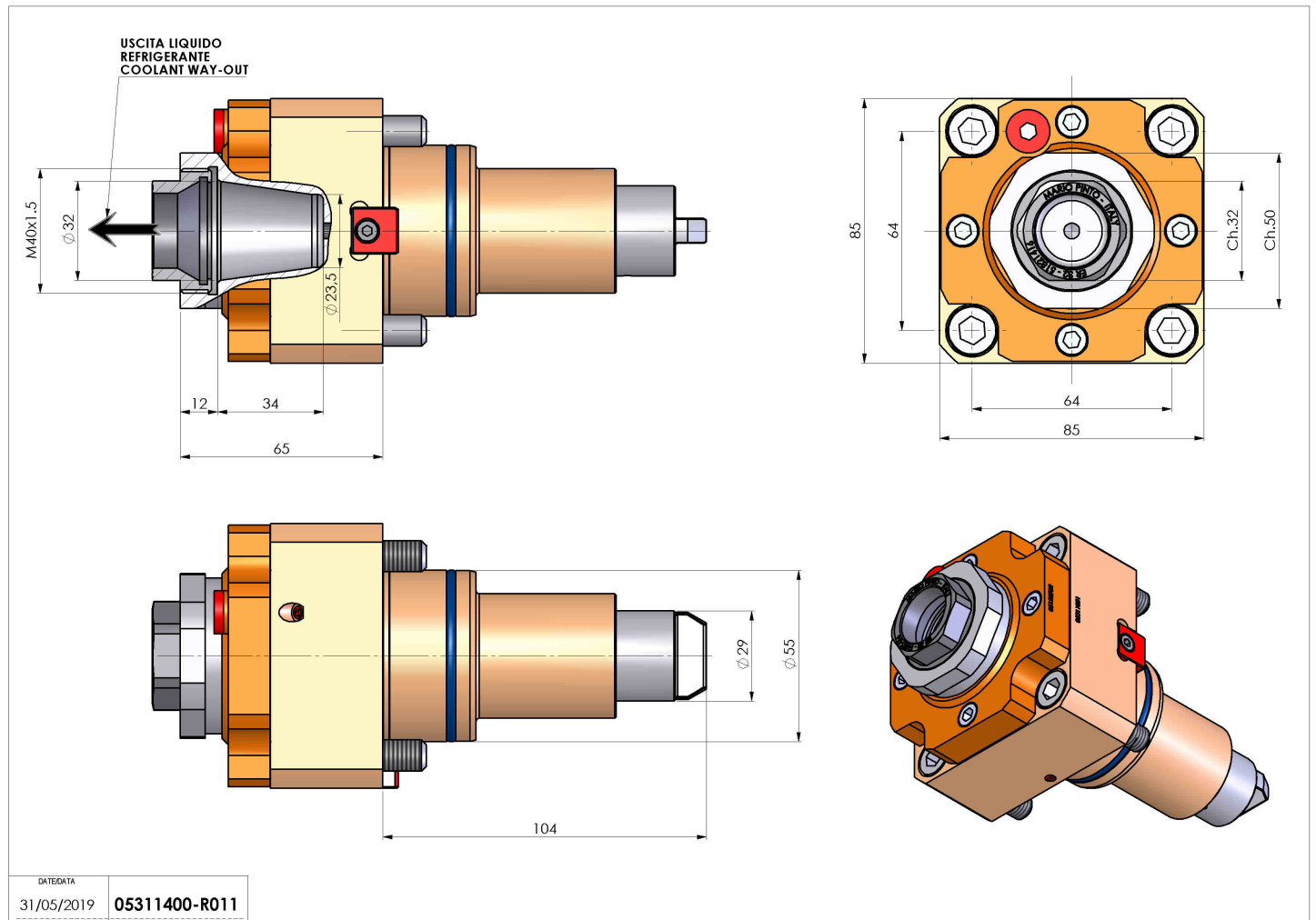

DATE/DATE	31/05/2019	05311400-R011
-----------	------------	---------------

Salvo modifiche tecniche