

05078600 - LT-S D60 ER25 RF H73

Tipo	LT-S Portautensili dritto
Attacco	CILINDRICO 60
Uscita utensile	Portapinza ER 25
Raffreddamento	Refrigerazione interna
Senso di rotazione	r1  r2 
Velocità max [1/min]	6000
Coppia max [Nm]	63
Rapporto	1:1
H [mm]	73
Pressione max [bar]	20
Accessori	N.D.
Note	N.D.
Note per il montaggio	N.D.

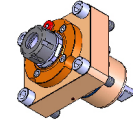

Verificare sempre gli ingombri del portautensile in torretta

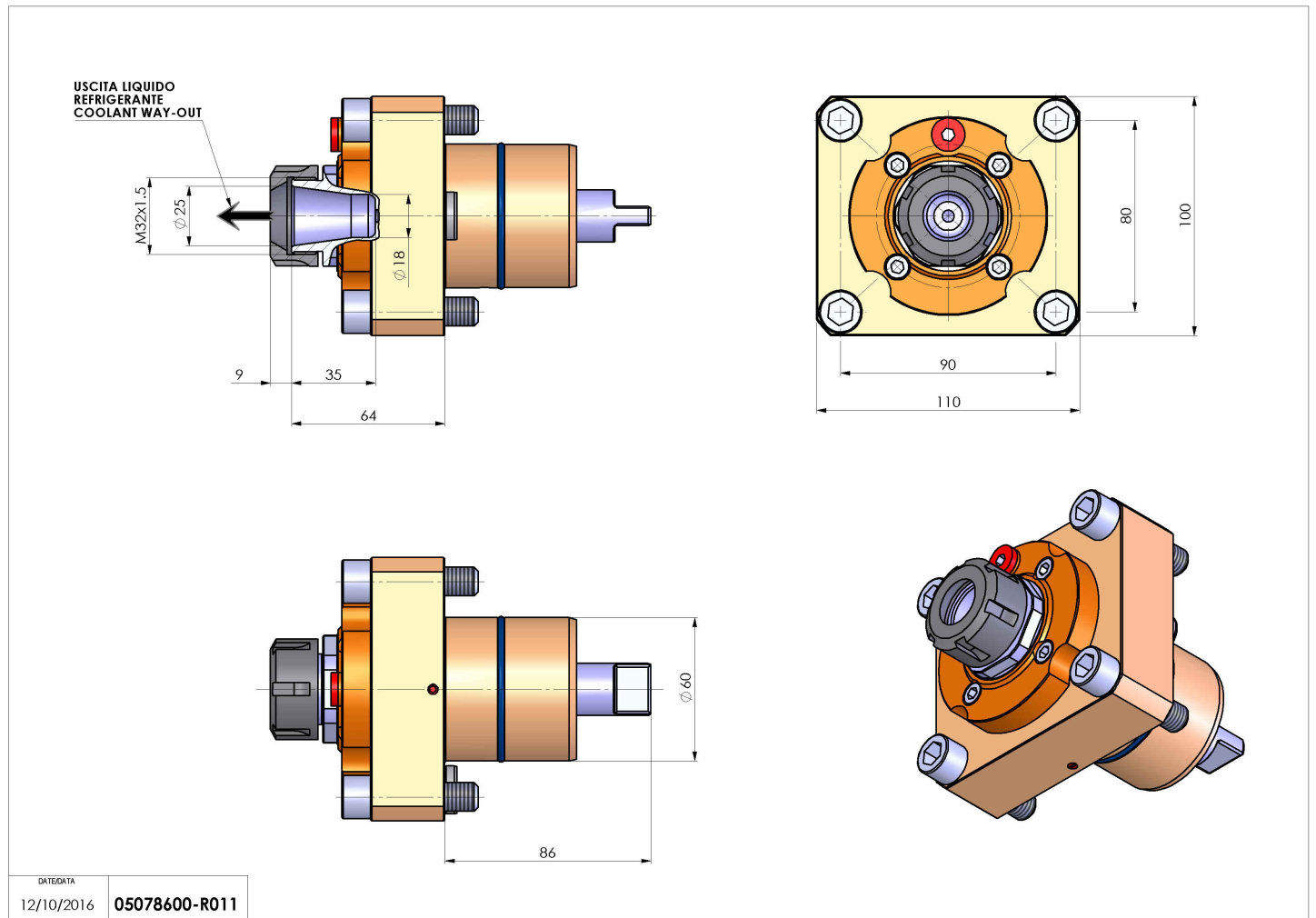

DATE/DATE	05078600-R011
12/10/2016	

Salvo modifiche tecniche