



05072600 - LT-S D55 ER25 RF H65 BI

Tipo	LT-S Portautensili dritto
Attacco	CILINDRICO 55
Uscita utensile	Portapinza ER 25
Raffreddamento	Refrigerazione interna
Senso di rotazione	r1  r2 
Velocità max [1/min]	6000
Coppia max [Nm]	40
Rapporto	1:1
H [mm]	65
Pressione max [bar]	20
Accessori	Chiave albero, chiave ghiera, ghiera per pinze ER
Note	N.D.
Note per il montaggio	N.D.



Verificare sempre gli ingombri del portautensile in torretta

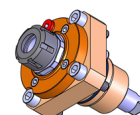
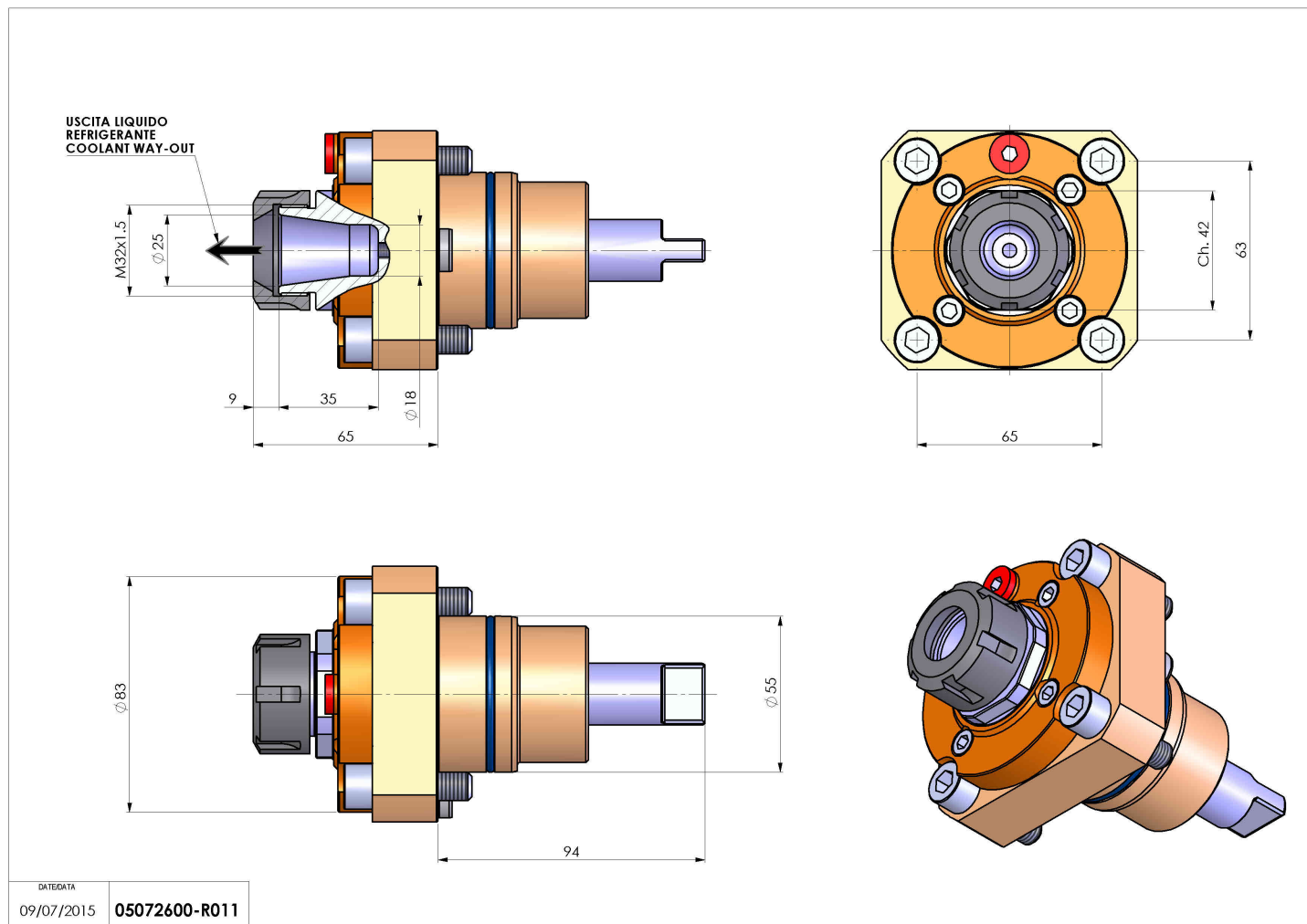

Salvo modifiche tecniche