



05053899 - LT-A VDI40 ER32F L RF REG H130

Tipo	LT-A Portautensili angolare a 90°
Attacco	VDI 40
Uscita utensile	Portapinza ER 32 F - ghiera interna
Raffreddamento	Refrigerazione interna
Senso di rotazione	r1  r2 
Velocità max [1/min]	6000
Coppia max [Nm]	63
Rapporto	1:1
H [mm]	130
H1 [mm]	38
Pressione max [bar]	20
Accessori	N.D.
Note	N.D.
Note per il montaggio	Solo per mandrino principale

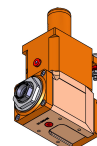

ATTENZIONE: VERIFICARE L'ORIENTAMENTO DELLA DENTATURA VDI

Verificare sempre gli ingombri del portautensile in torretta

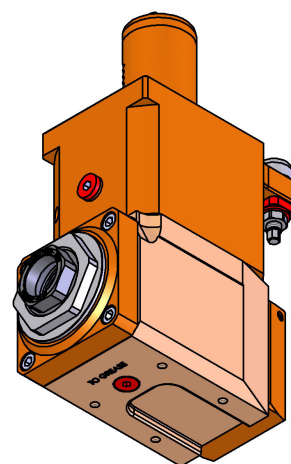
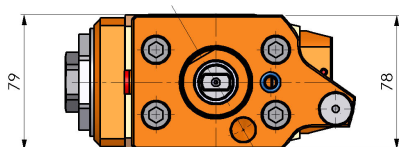
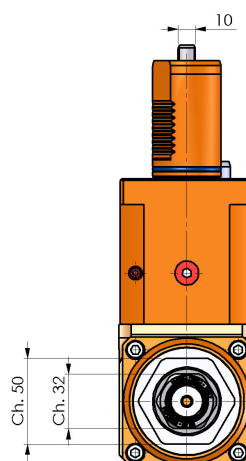
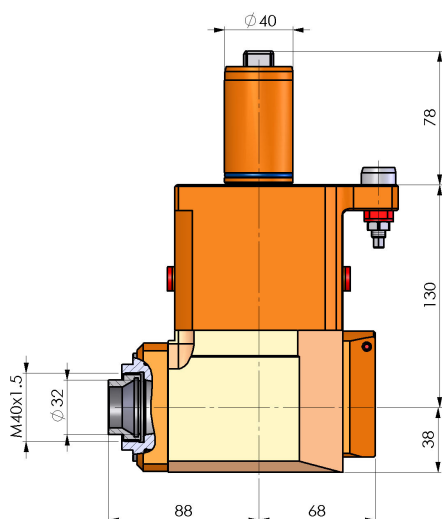

DATE/GATA
26/06/2024 05053899-R011

Salvo modifiche tecniche