



## 05051300 - LT-S VDI40 DIN22 OFS50 H100 MZ

<b>Tipo</b>	LT-S OFS Portautensili dritto offset
<b>Attacco</b>	VDI 40
<b>Uscita utensile</b>	Portafrese DIN138 D22
<b>Raffreddamento</b>	Refrigerazione esterna
<b>Offset [mm]</b>	50
<b>Senso di rotazione</b>	r1  r2 
<b>Velocità max [1/min]</b>	6000
<b>Coppia max [Nm]</b>	63
<b>Rapporto</b>	1:1
<b>H [mm]</b>	100
<b>Accessori</b>	N.D.
<b>Note</b>	N.D.
<b>Note per il montaggio</b>	Solo per mandrino principale

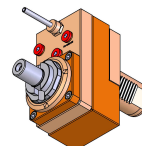

**ATTENZIONE: VERIFICARE L'ORIENTAMENTO DELLA DENTATURA VDI**

Verificare sempre gli ingombri del portautensile in torretta

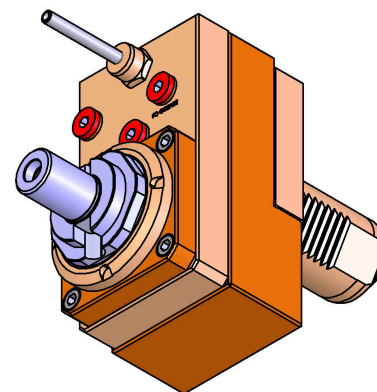
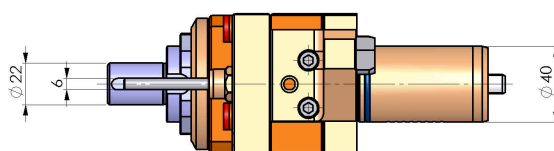
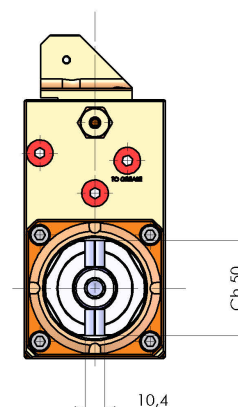
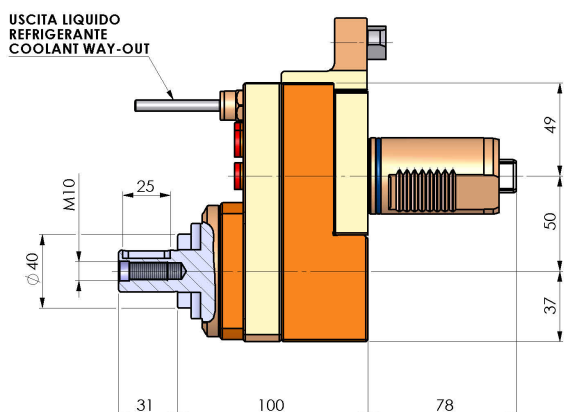

DATE/ATA	08/09/2015	05051300-R011
----------	------------	---------------

Salvo modifiche tecniche