



05039400 - LT-T D55 ER20F H72-152

Tipo	LT-T Portautensili tiltabile
Attacco	CILINDRICO 55
Uscita utensile	Portapinza ER 20 F - ghiera interna
Raffreddamento	Refrigerazione esterna
Senso di rotazione	r1  r2 
Velocità max [1/min]	6000
Coppia max [Nm]	20
Rapporto	1:1
H [mm]	72-152
Accessori	N.D.
Note	N.D.
Note per il montaggio	N.D.



Verificare sempre gli ingombri del portautensile in torretta

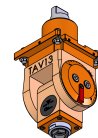
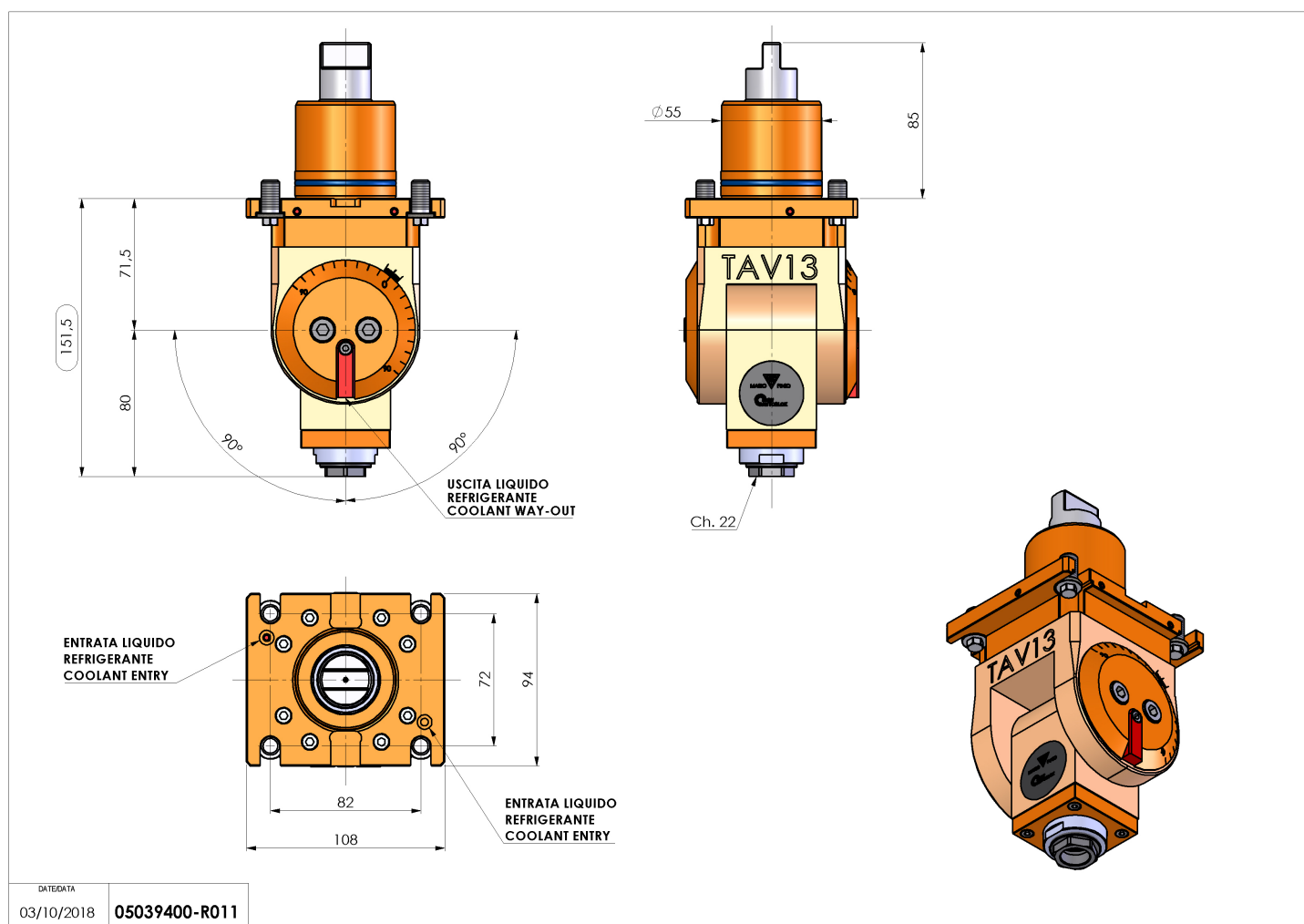

Salvo modifiche tecniche