



05037600 - LT-A D50 ER32F-32F H80

Tipo	LT-A DBL Portautensili angolare doppio a 90°
Attacco	CILINDRICO 50
Uscita utensile	Portapinza ER 32 F - ghiera interna
Raffreddamento	Refrigerazione esterna
Senso di rotazione	r1  r2  r3 
Velocità max [1/min]	6000
Coppia max [Nm]	63
Rapporto	1:1
H [mm]	80
H1 [mm]	38
Accessori	N.D.
Note	N.D.
Note per il montaggio	N.D.



Verificare sempre gli ingombri del portautensile in torretta

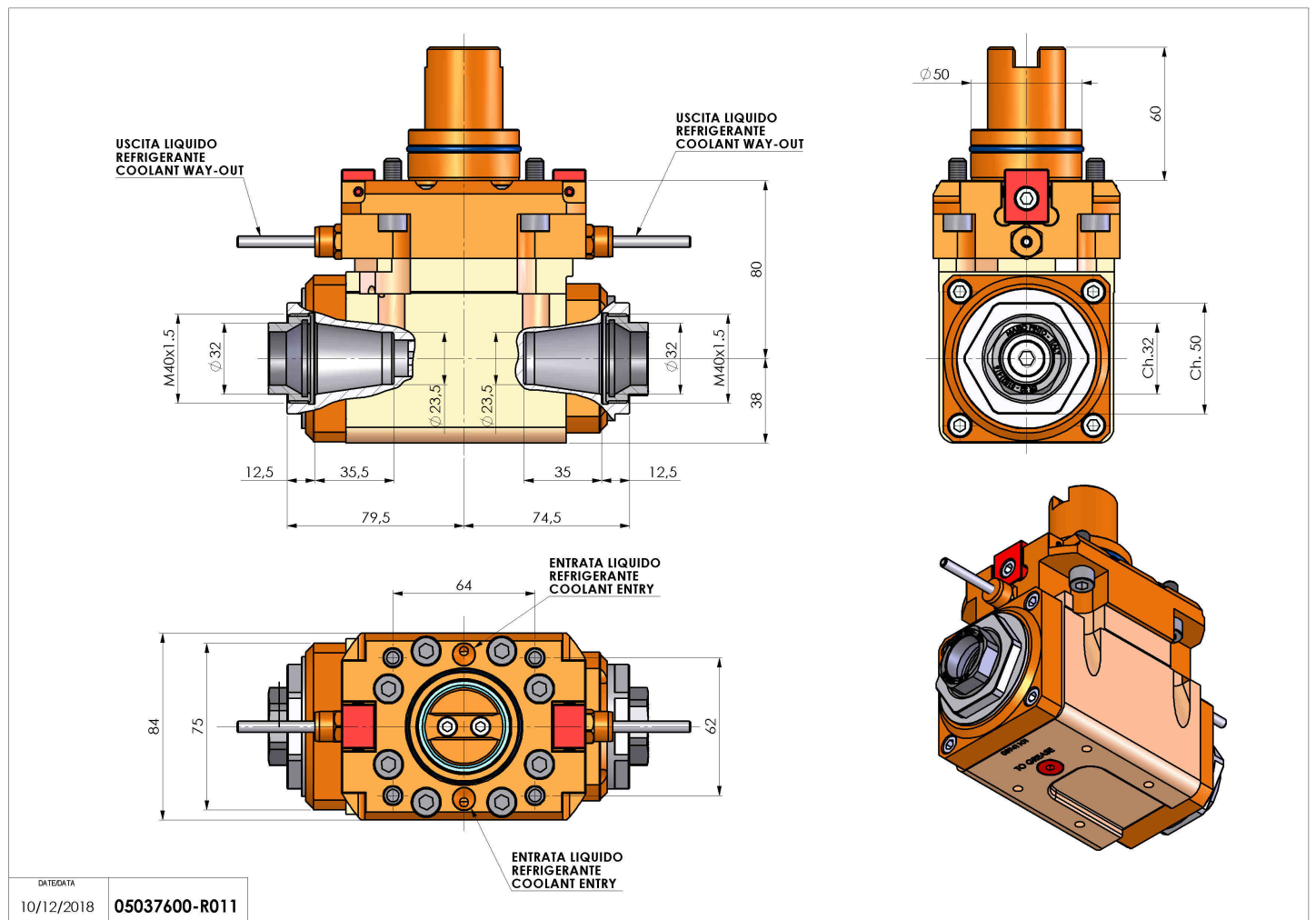

Salvo modifiche tecniche