

05014000 - LT-S D44 ER25F RF H62 NK

Tipo	LT-S Portautensili dritto
Attacco	CILINDRICO 44
Uscita utensile	Portapinza ER 25 F - ghiera interna
Raffreddamento	Refrigerazione interna
Senso di rotazione	r1 r2
Velocità max [1/min]	6000
Coppia max [Nm]	40
Rapporto	1:1
H [mm]	62
Pressione max [bar]	20
Accessori	Chiave albero, chiave ghiera, ghiera per pinze ER
Note	N.D.
Note per il montaggio	N.D.

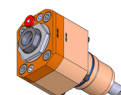

Verificare sempre gli ingombri del portautensile in torretta

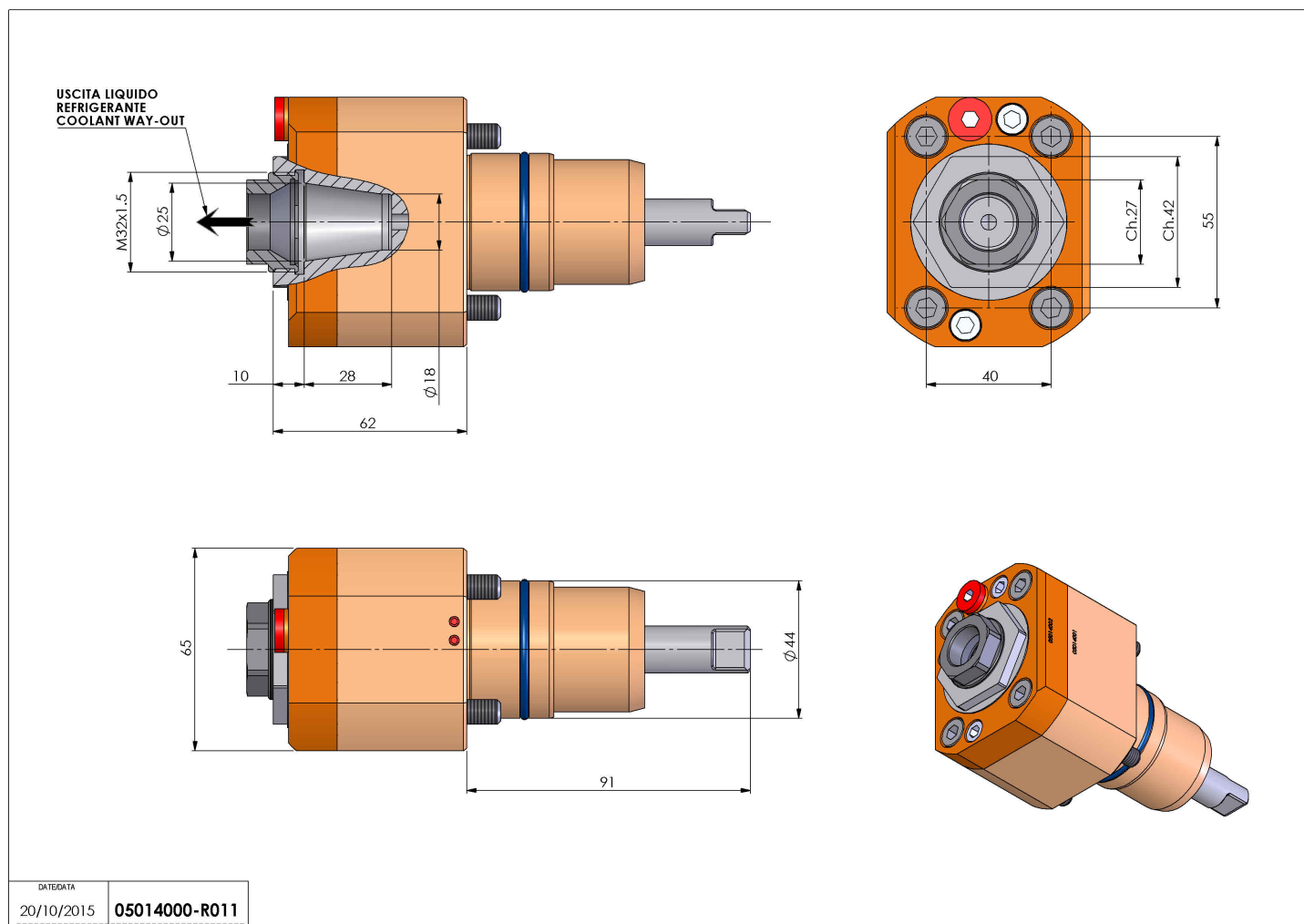

Salvo modifiche tecniche