



05012300 - LT-S D65 DIN138-22 H73 NK

Tipo	LT-S Portautensili dritto
Attacco	CILINDRICO 65
Uscita utensile	Portafrese DIN138 D22
Raffreddamento	Refrigerazione esterna
Senso di rotazione	r1  r2 
Velocità max [1/min]	6000
Coppia max [Nm]	63
Rapporto	1:1
H [mm]	73
Accessori	Chiave albero, chiave croce + gruppo accessori portafresa
Note	N.D.
Note per il montaggio	N.D.



Verificare sempre gli ingombri del portautensile in torretta

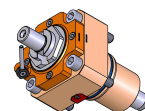
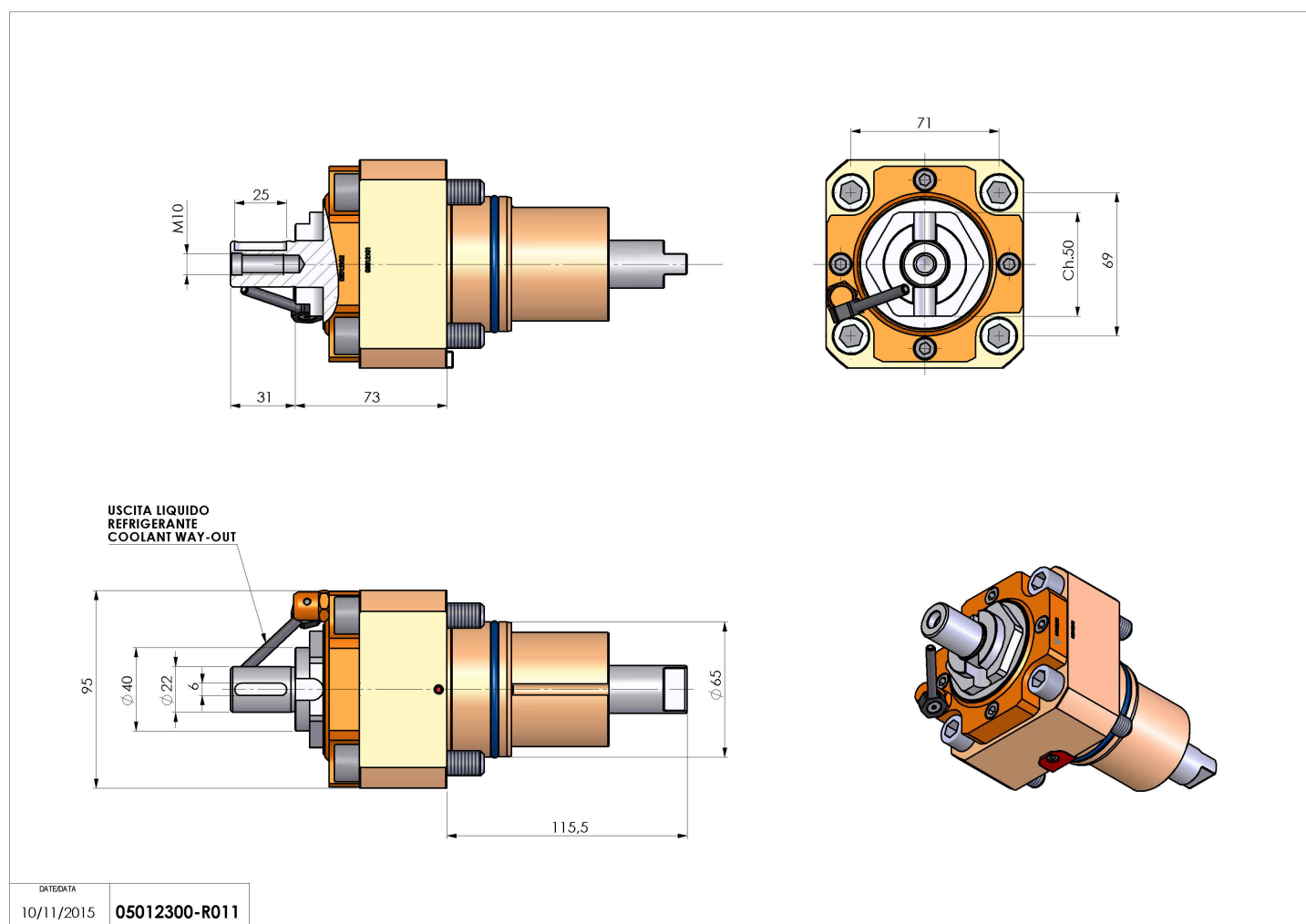

Salvo modifiche tecniche

DATE/ATA
10/11/2015 05012300-R011