



## 05385300 - LT-S D65 ER25F RF H69

<b>Tipo</b>	LT-S Portautensili dritto
<b>Attacco</b>	CILINDRICO 65
<b>Uscita utensile</b>	Portapinza ER 25 F - ghiera interna
<b>Raffreddamento</b>	Refrigerazione interna
<b>Senso di rotazione</b>	r1  r2 
<b>Velocità max [1/min]</b>	6000
<b>Coppia max [Nm]</b>	70
<b>Rapporto</b>	1:1
<b>H [mm]</b>	69
<b>Pressione max [bar]</b>	20
<b>Accessori</b>	N.D.
<b>Note</b>	N.D.
<b>Note per il montaggio</b>	N.D.



Verificare sempre gli ingombri del portautensile in torretta

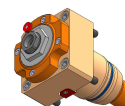
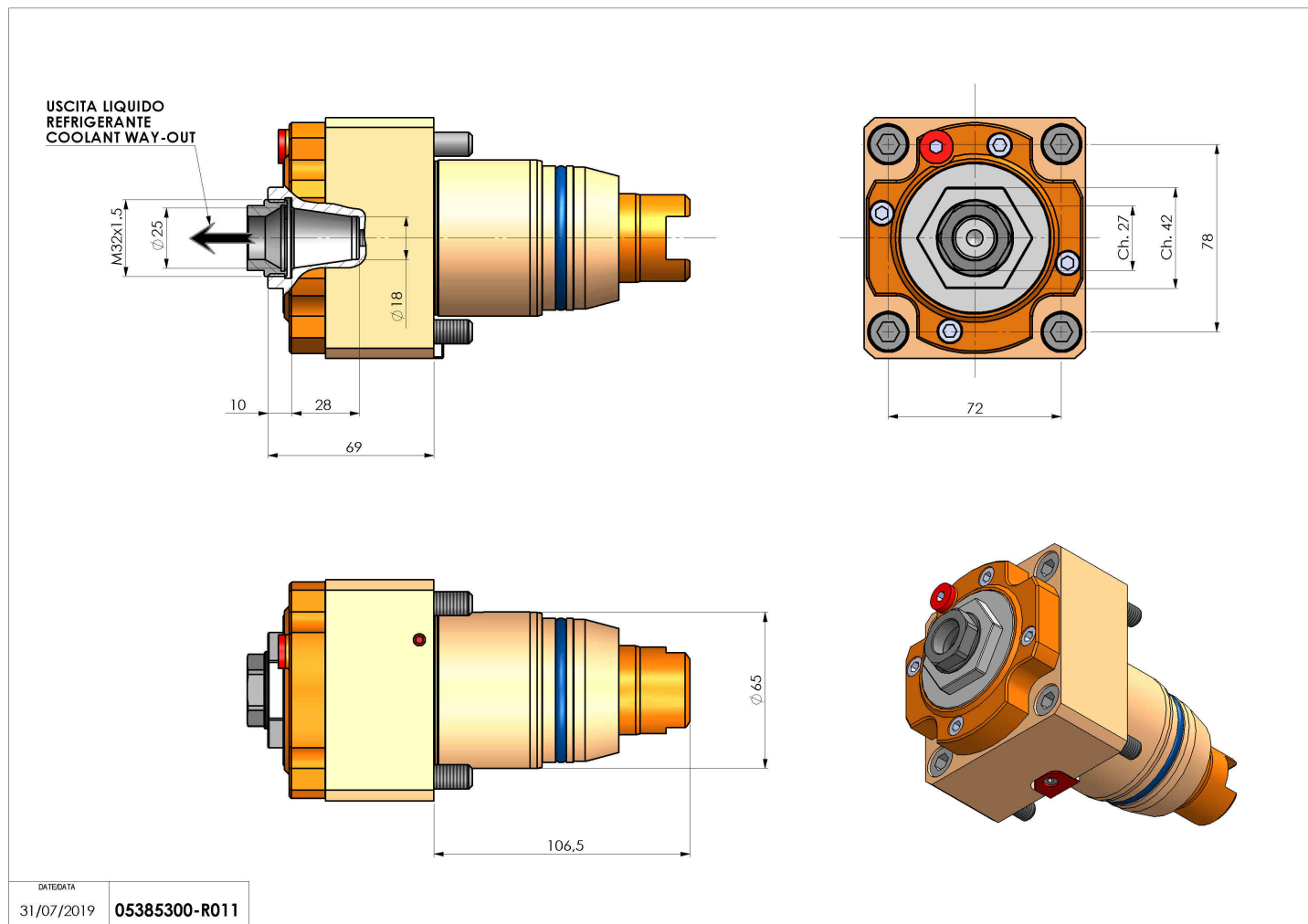

Salvo modifiche tecniche