



05360600 - LT-S D60 C40 HRF H70

Tipo	LT-S Portautensili dritto
Attacco	CILINDRICO 60
Uscita utensile	Poligonale C40 ISO 26623-1
Raffreddamento	Refrigerazione interna HRF
Senso di rotazione	r1  r2 
Velocità max [1/min]	6000
Coppia max [Nm]	80
Rapporto	1:1
H [mm]	70
Pressione max [bar]	70
Accessori	N.D.
Note	N.D.
Note per il montaggio	N.D.



Verificare sempre gli ingombri del portautensile in torretta

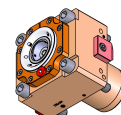
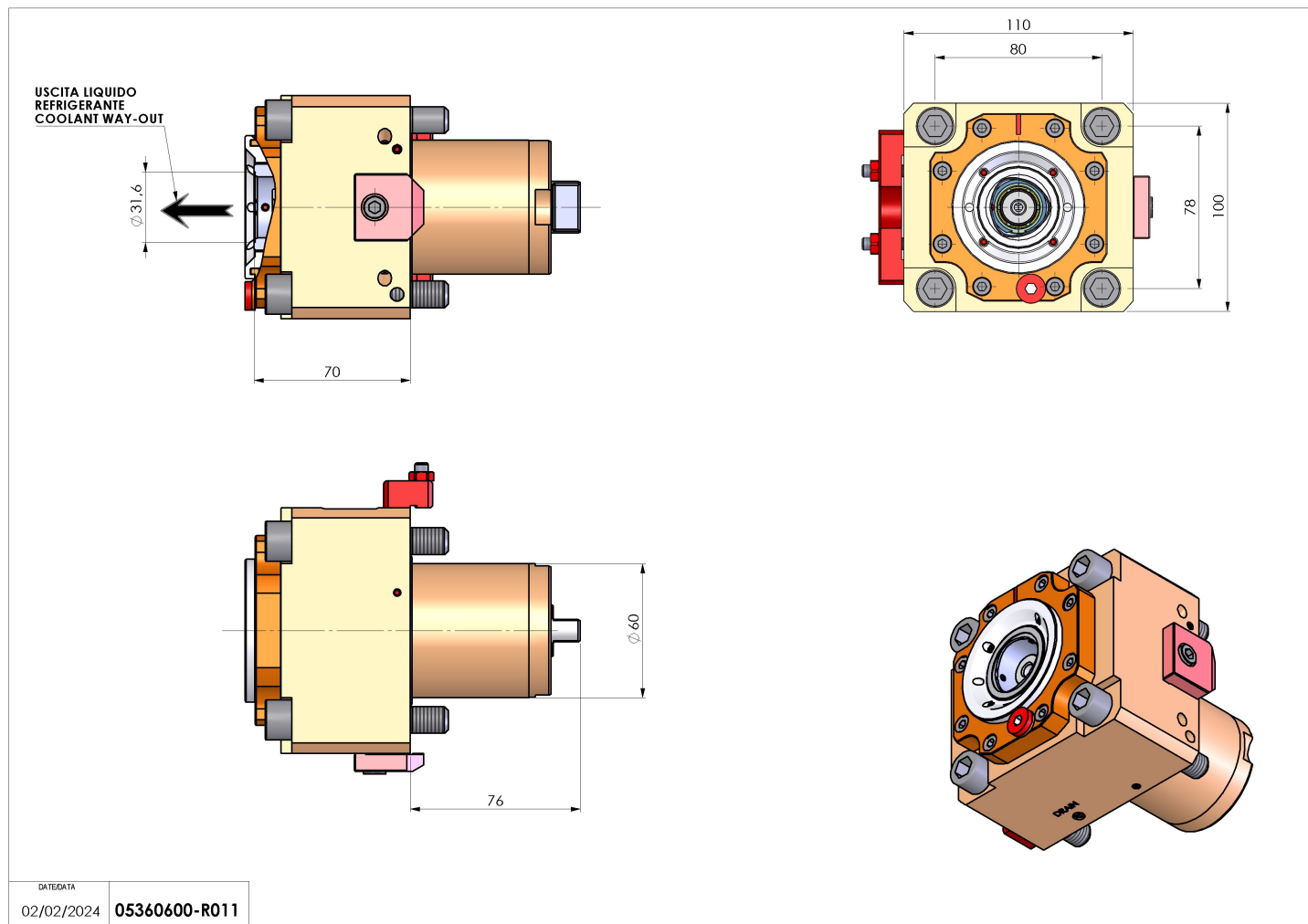

Salvo modifiche tecniche

DATE/DATE
02/02/2024 05360600-R011