



05355200 - LT-S VDI40 DIN138-22 H72 MZ

Tipo	LT-S Portautensili dritto
Attacco	VDI 40
Uscita utensile	Portafresa DIN138 22
Raffreddamento	Refrigerazione esterna
Senso di rotazione	r1  r2 
Velocità max [1/min]	6000
Coppia max [Nm]	63
Rapporto	1:1
H [mm]	72
Accessori	Chiave albero, chiave croce + gruppo accessori portafresa
Note	N.D.
Note per il montaggio	N.D.

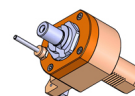

ATTENZIONE: VERIFICARE L'ORIENTAMENTO DELLA DENTATURA VDI

Verificare sempre gli ingombri del portautensile in torretta

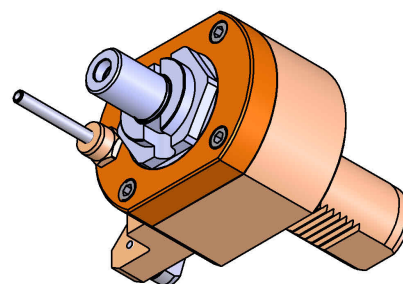
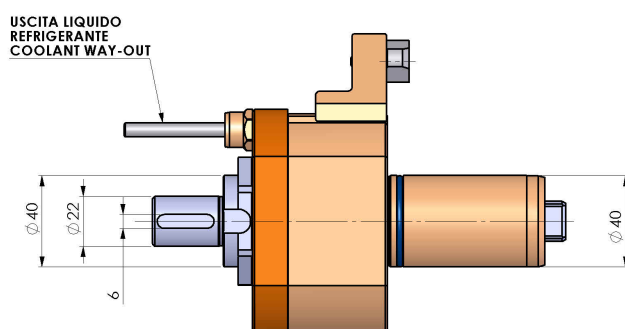
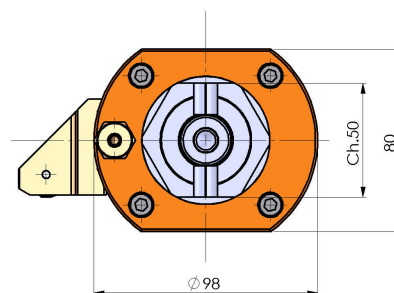
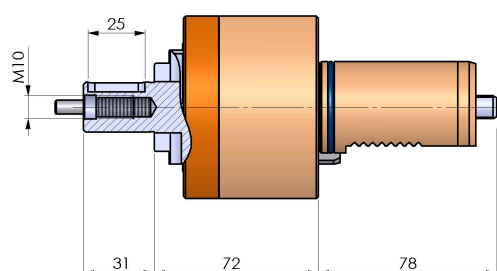

DATE/ATA	05355200-R011
11/09/2015	

Salvo modifiche tecniche