

05292600 - LT-S D32 WELDON20 RF H68

Tipo	LT-S Portautensili dritto
Attacco	CILINDRICO 32
Uscita utensile	Weldon 20 DIN1835B
Raffreddamento	Refrigerazione interna
Senso di rotazione	r1 r2
Velocità max [1/min]	6000
Coppia max [Nm]	70
Rapporto	1:1
H [mm]	68
Pressione max [bar]	20
Accessori	N.D.
Note	N.D.
Note per il montaggio	N.D.

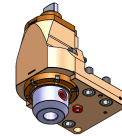

Verificare sempre gli ingombri del portautensile in torretta

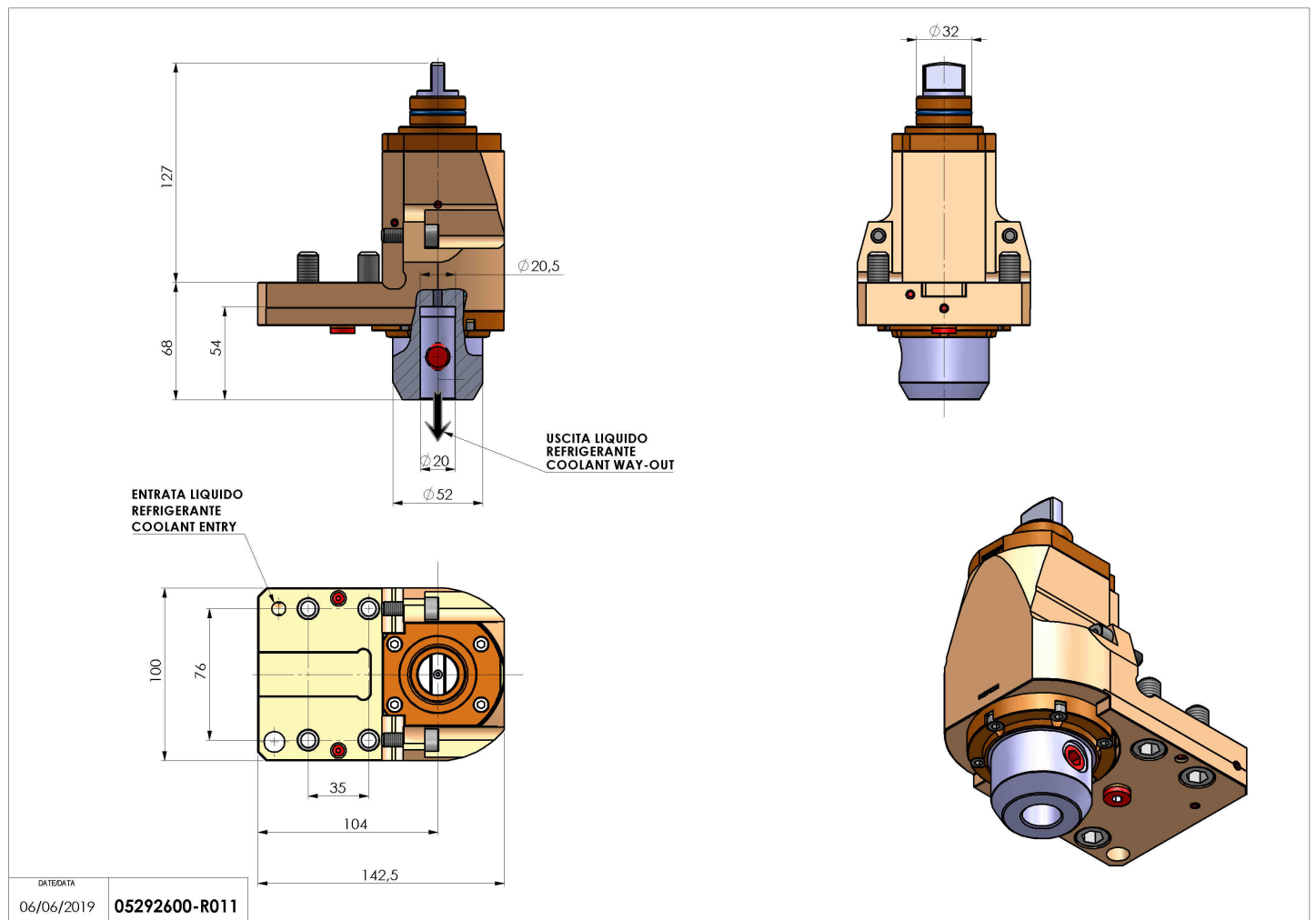

Salvo modifiche tecniche