

05263500 - LT-S D55.4 ER32 H70

Tipo	LT-S Portautensili dritto
Attacco	CILINDRICO 55.4
Uscita utensile	Portapinza ER 32
Raffreddamento	Refrigerazione esterna
Senso di rotazione	r1  r2 
Velocità max [1/min]	6000
Coppia max [Nm]	40
Rapporto	1:1
H [mm]	70
Accessori	N.D.
Note	N.D.
Note per il montaggio	N.D.

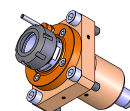

Verificare sempre gli ingombri del portautensile in torretta

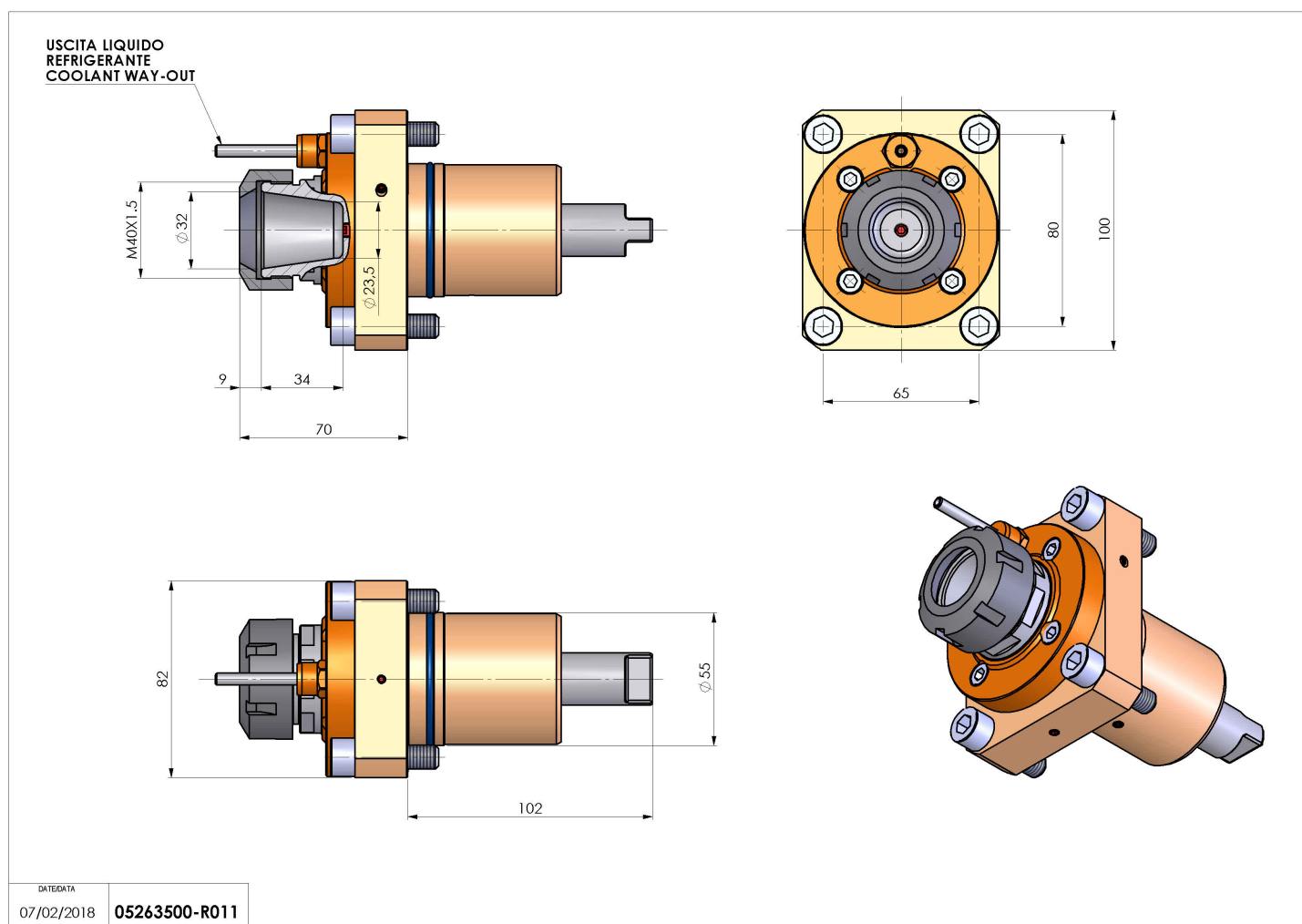

Salvo modifiche tecniche

DATE/DATE
07/02/2018 05263500-R011