

05128000 - LT-S BMT55 ER32F RF H66 DW

Tipo	LT-S Portautensili dritto
Attacco	BMT 55
Uscita utensile	Portapinza ER 32 F - ghiera interna
Raffreddamento	Refrigerazione interna
Senso di rotazione	r1 r2
Velocità max [1/min]	6000
Coppia max [Nm]	40
Rapporto	1:1
H [mm]	66
Pressione max [bar]	20
Accessori	Chiave albero, chiave ghiera, ghiera per pinze ER
Note	N.D.
Note per il montaggio	N.D.

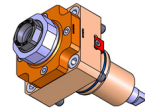

Verificare sempre gli ingombri del portautensile in torretta

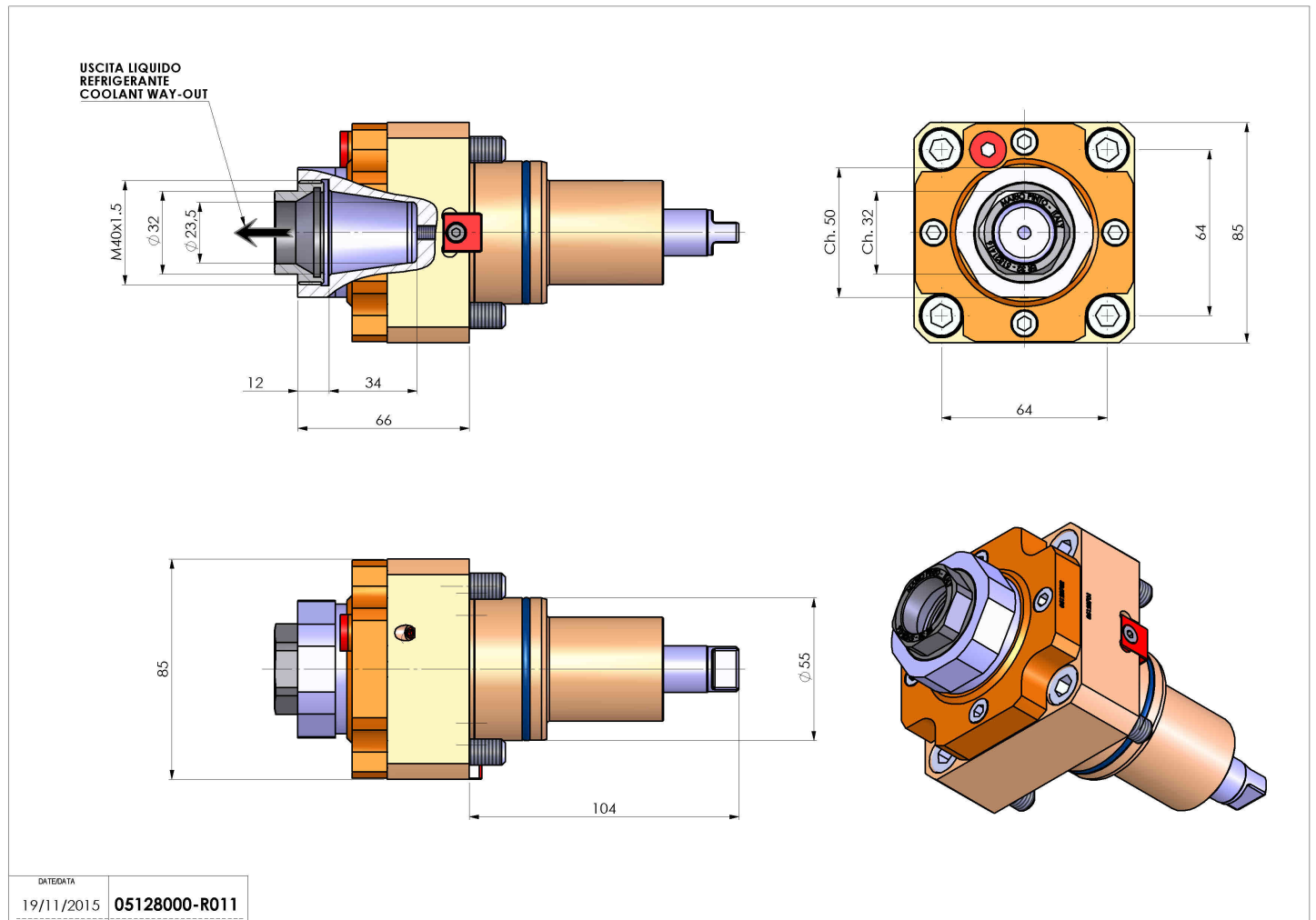

Salvo modifiche tecniche