

06306300 - TH-BRB BMT75 D40 H60

Type	TH-BRB Boring bar holder
Mounting	BMT 75
Tool output	Boring Bar Holder 40
Coolant	External / Internal coolant
H [mm]	60

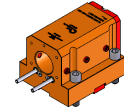

Accessories	N.A.
Notes	N.A.
Mounting tips	N.A.

Always check live tool dimensions on the turret

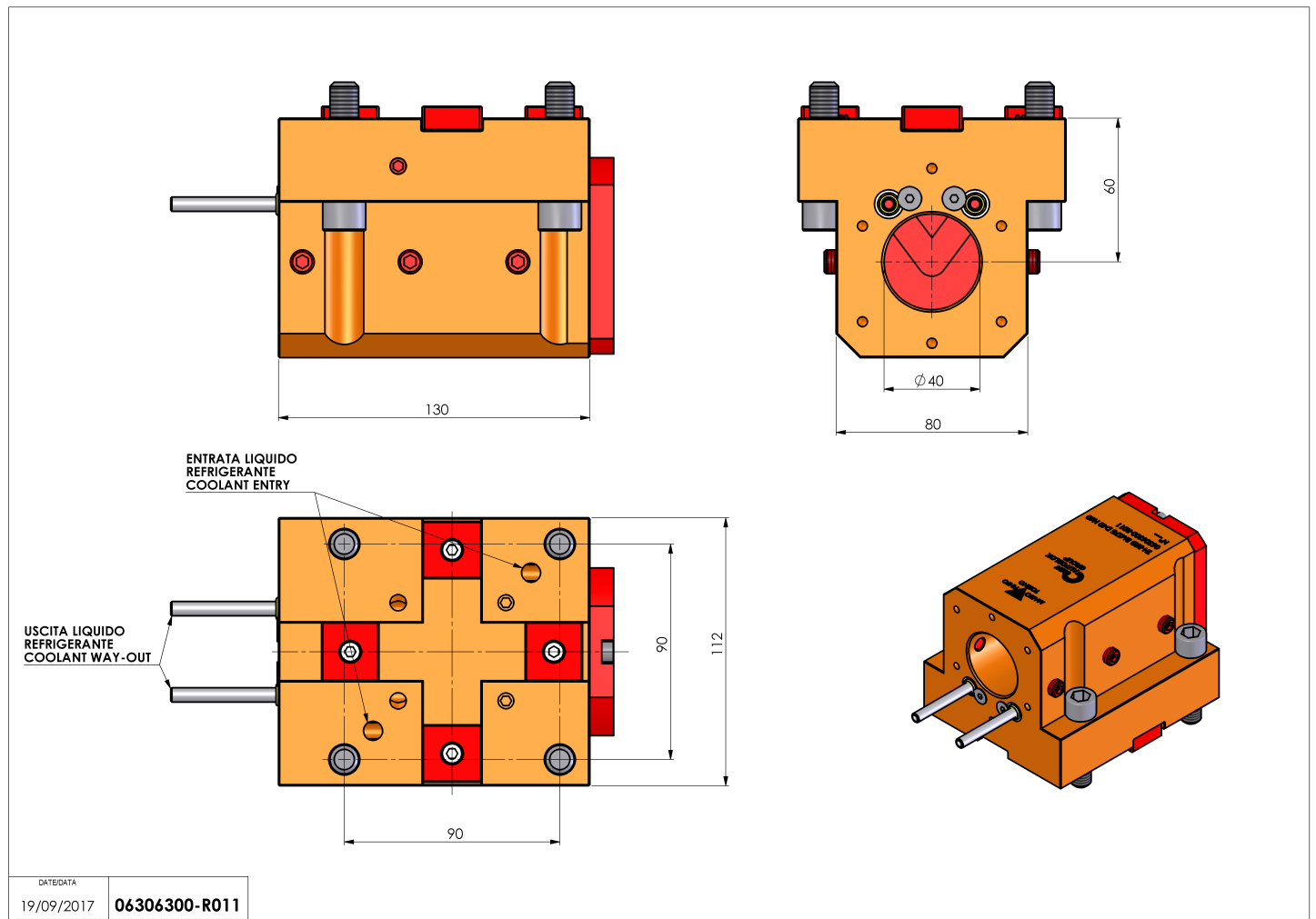

DATE/DATE	19/09/2017	06306300-R011
-----------	------------	---------------

Subject to technical changes