

06305100 - TH-RAD BMT65 DP Q25 H75

Type	TH-RAD Radial Tool holder
Mounting	BMT 65
Tool output	Radial Square Tool Holder 25x25
Coolant	External coolant
H [mm]	75
Accessories	N.A.
Notes	N.A.
Mounting tips	N.A.

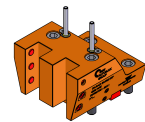

Always check live tool dimensions on the turret

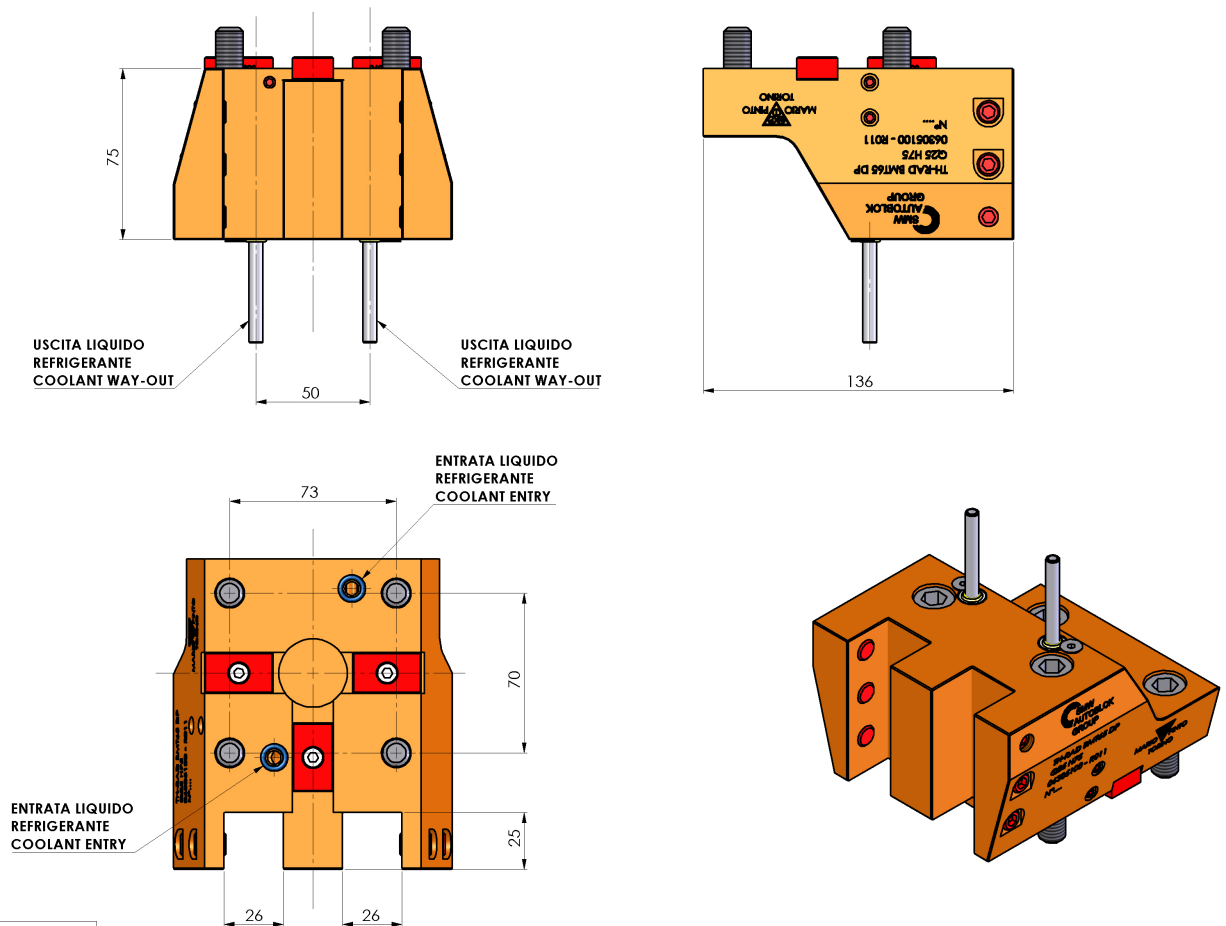

DATE/DATE	31/08/2018	06305100-R011
-----------	------------	---------------

Subject to technical changes