

## 06300000 - TH-AX BMT45 20X20 H65

Type	TH-AX Axial Tool holder
Mounting	BMT 45
Tool output	Axial Square Tool Holder 20x20
Coolant	External coolant
H [mm]	65

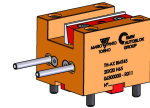

Accessories	N.A.
Notes	N.A.
Mounting tips	N.A.

Always check live tool dimensions on the turret

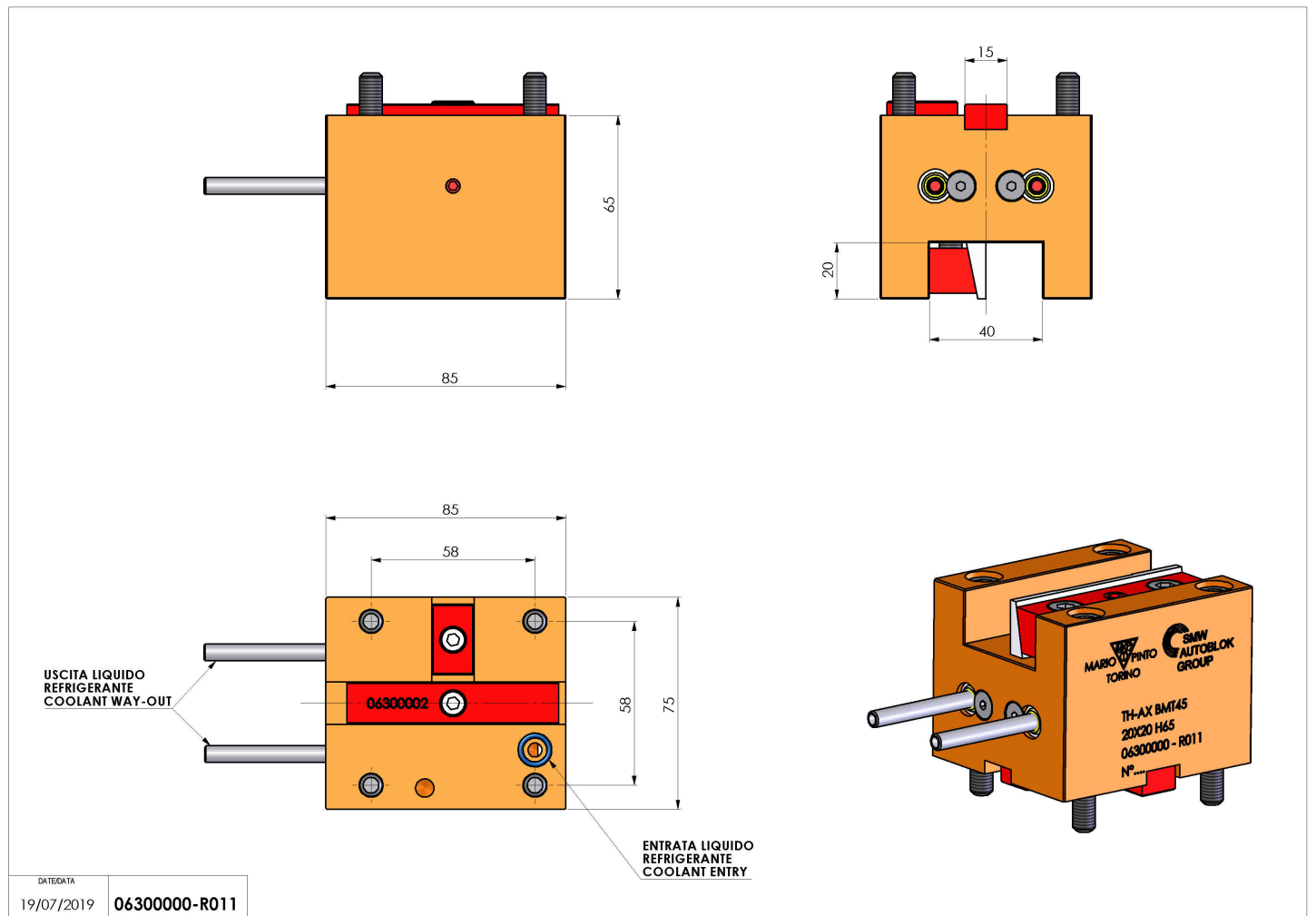

DATE/DATE	
19/07/2019	06300000-R011

Subject to technical changes