

06258800 - TH-BRB D68 D32 H90 MZ

Type	TH-BRB Boring bar holder
Mounting	CYLINDRICAL SHANK 68
Tool output	Boring Bar Holder 32
Coolant	External / Internal coolant
H [mm]	90

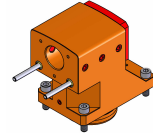

Accessories	N.A.
Notes	N.A.
Mounting tips	N.A.

Always check live tool dimensions on the turret

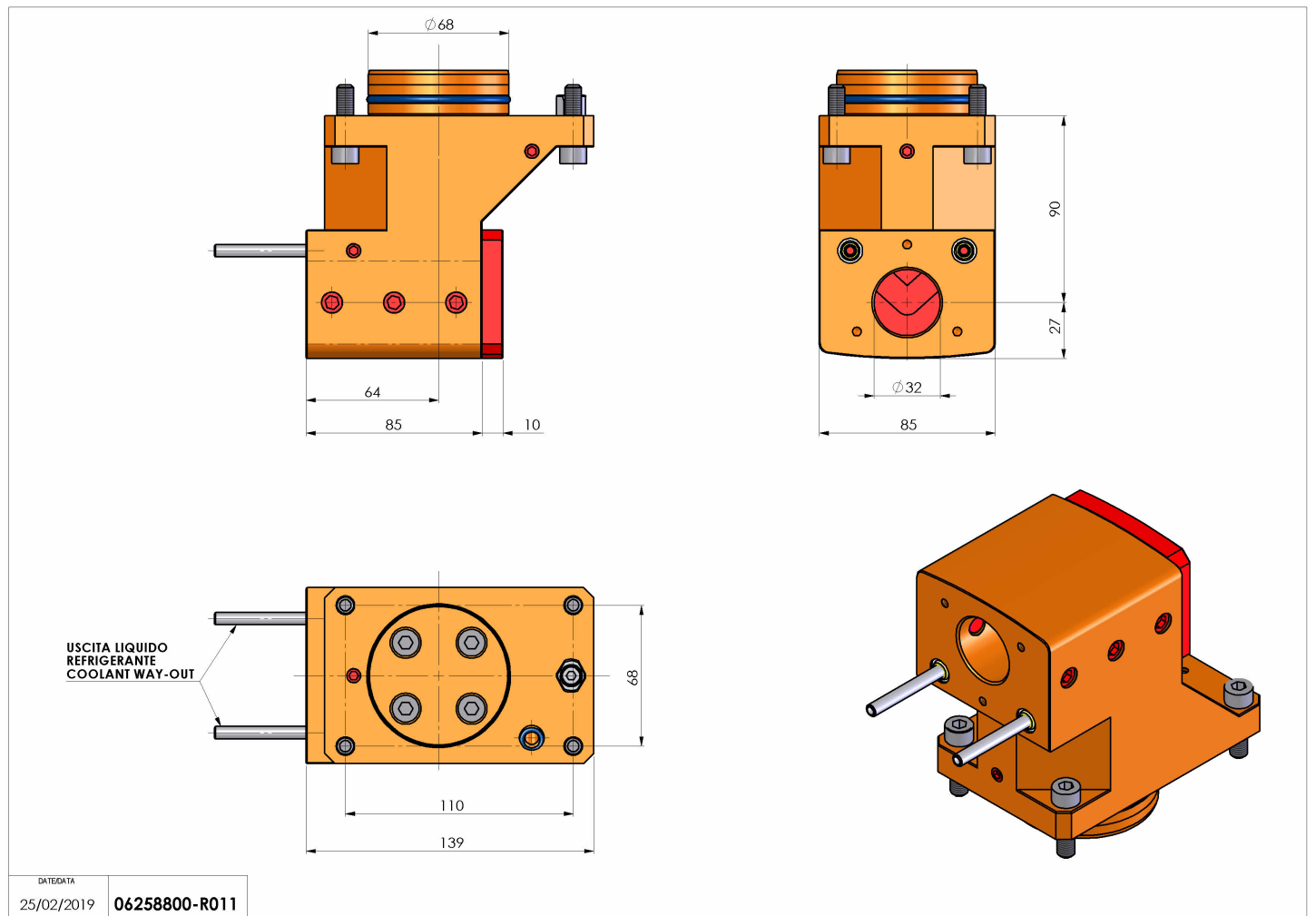

Subject to technical changes