

06254400 - TH-RAD VDI50 C50 RF H115

Type	TH-RAD Radial Tool holder
Mounting	VDI 50
Tool output	Polygonal shank C50 ISO 26623-1
Coolant	Internal coolant
H [mm]	115

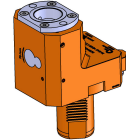

Accessories	N.A.
Notes	N.A.
Mounting tips	N.A.

ATTENTION: CHECK THE ORIENTATION OF THE VDI TEETH

Always check live tool dimensions on the turret

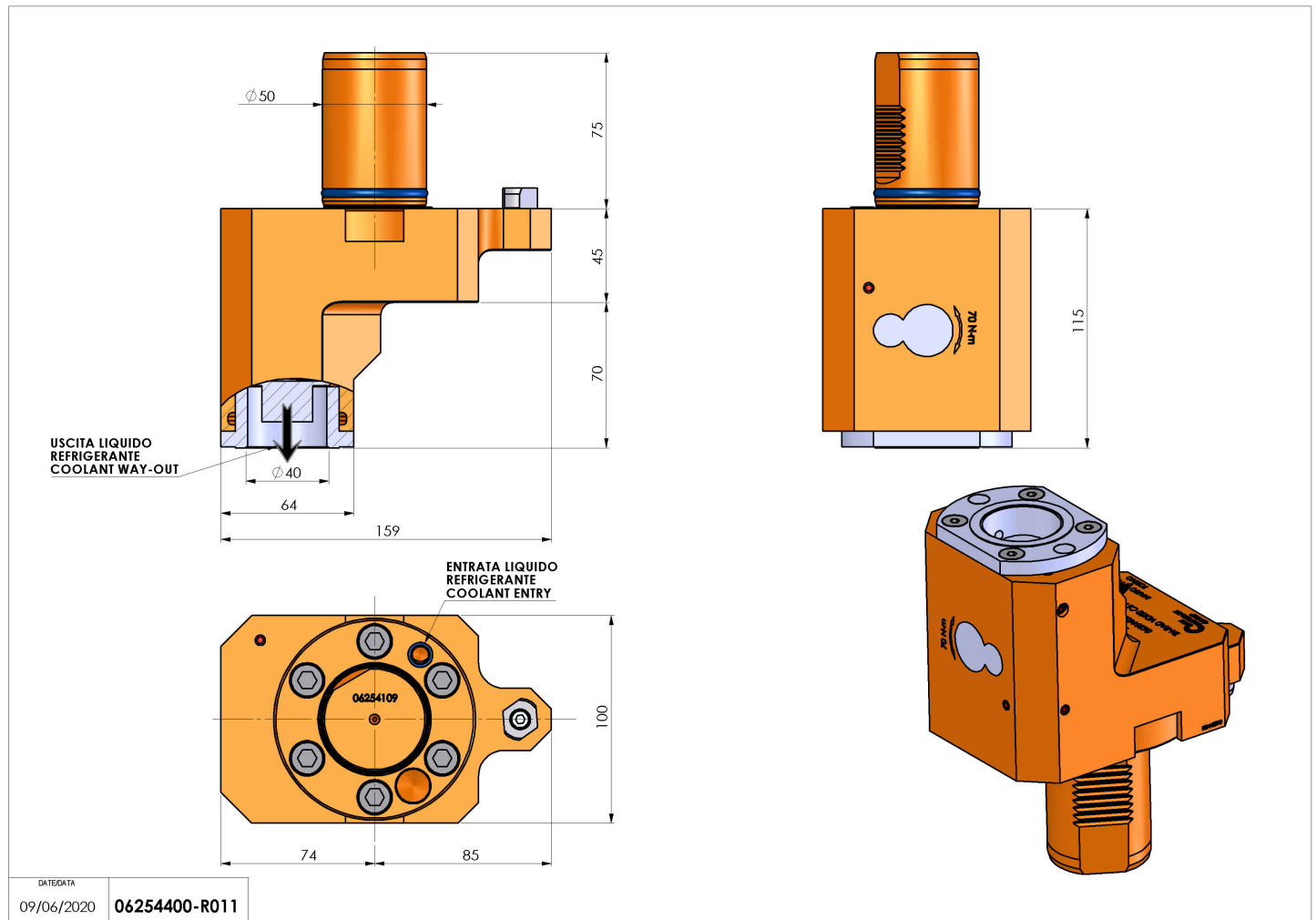

Subject to technical changes