

06254200 - TH-AX VDI50 C40 RF H175

Type	TH-AX Axial Tool holder
Mounting	VDI 50
Tool output	Polygonal shank C40 ISO 26623-1
Coolant	Internal coolant
H [mm]	175



Accessories	N.A.
Notes	N.A.
Mounting tips	N.A.

ATTENTION: CHECK THE ORIENTATION OF THE VDI TEETH

Always check live tool dimensions on the turret

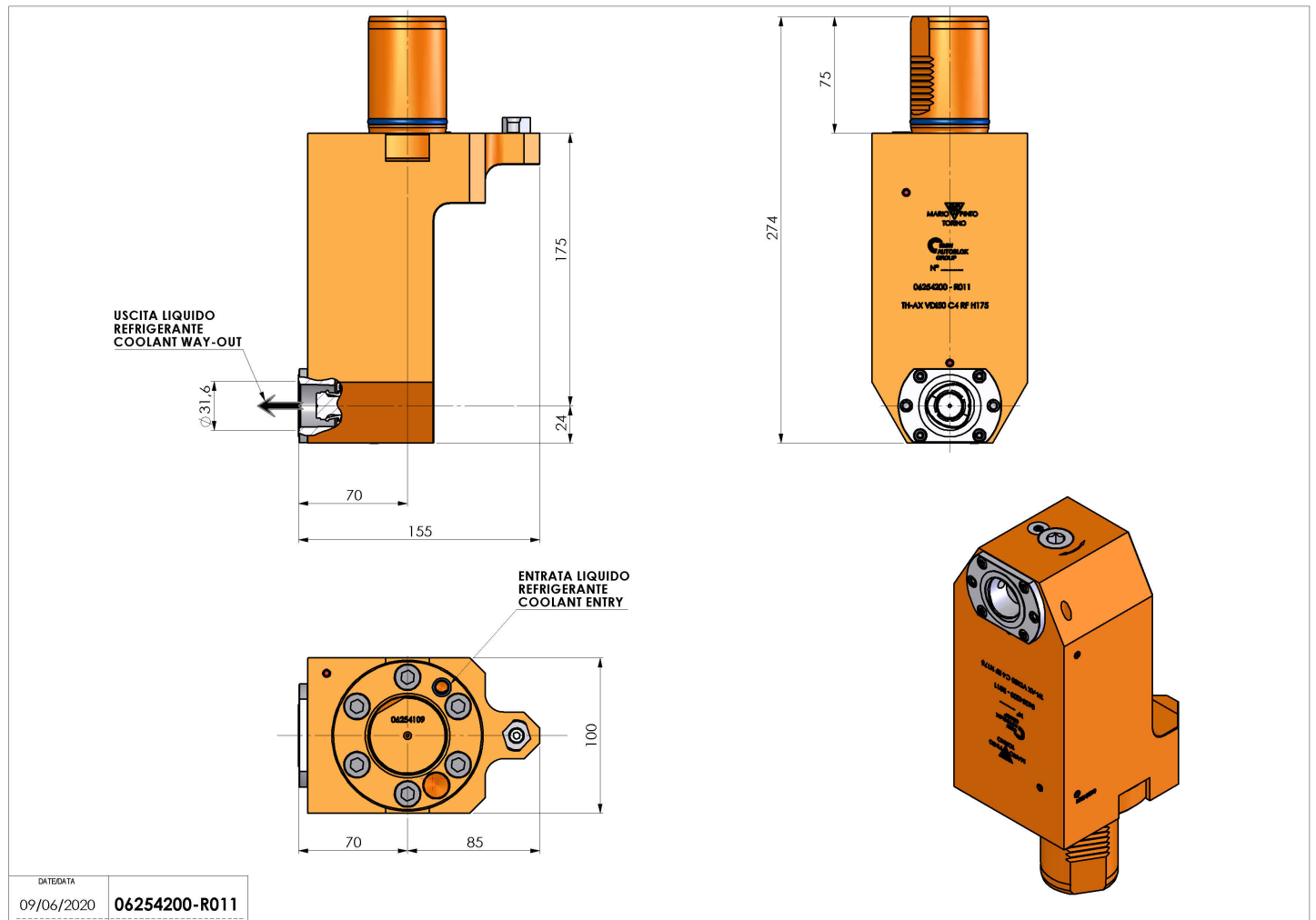

DATE/DATA	09/06/2020
	06254200-R011

Subject to technical changes