

# 06254000 - TH-RAD VDI50 H130 L86 DX-SX MZ

<b>Type</b>	TH-RAD Radial Tool holder
<b>Mounting</b>	VDI 50
<b>Tool output</b>	Radial Square Tool Holder 25x25
<b>Coolant</b>	External coolant
<b>H [mm]</b>	130

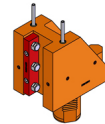

<b>Accessories</b>	N.A.
<b>Notes</b>	N.A.
<b>Mounting tips</b>	N.A.

**ATTENTION: CHECK THE ORIENTATION OF THE VDI TEETH**

Always check live tool dimensions on the turret

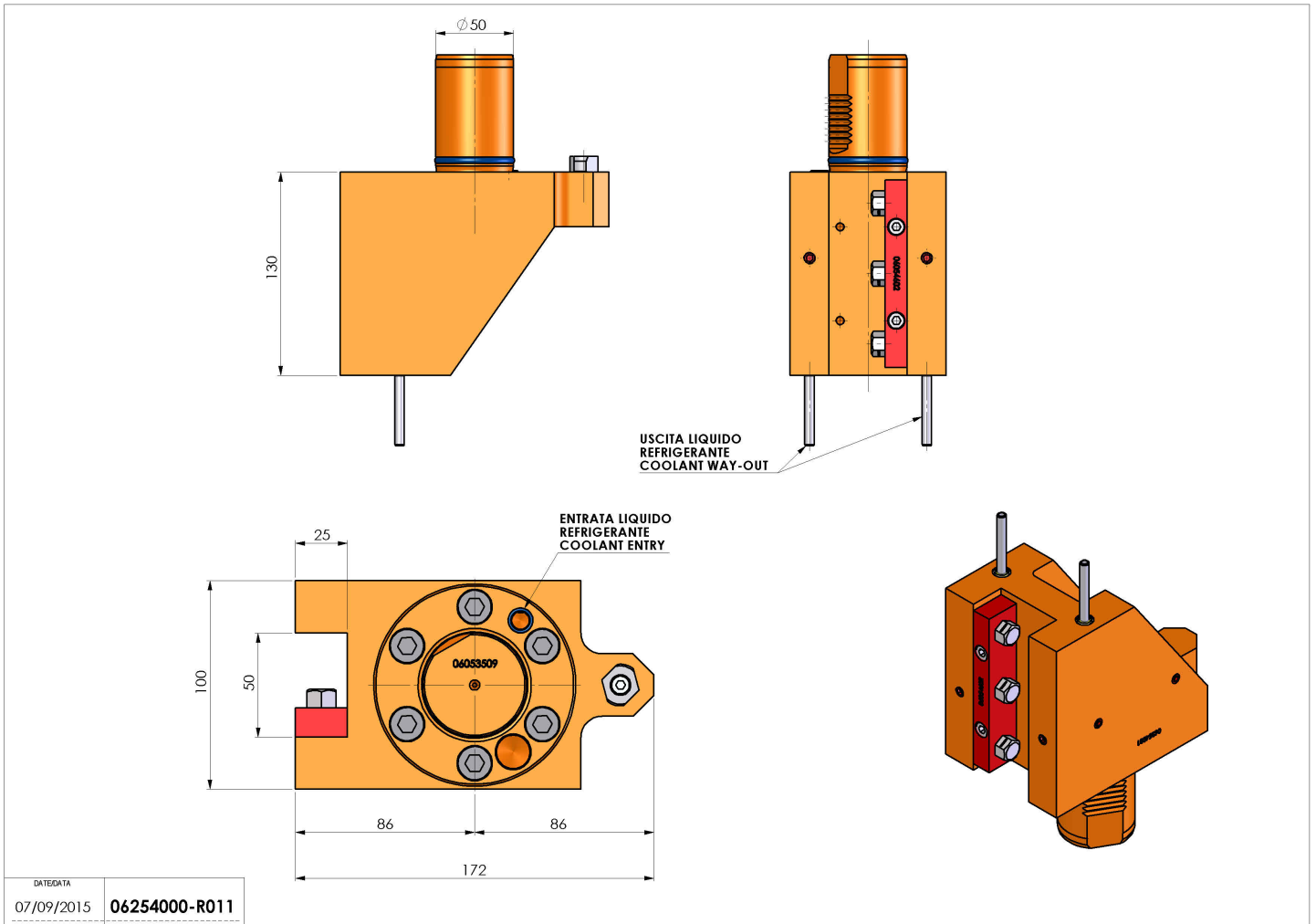

DATE/DATA	07/09/2015
	06254000-R011

Subject to technical changes