

# 06230900 - TH-BRB BMT65EM D40 H90

<b>Type</b>	TH-BRB Boring bar holder
<b>Mounting</b>	BMT 65 EM
<b>Tool output</b>	Boring Bar Holder 40
<b>Coolant</b>	External / Internal coolant
<b>H [mm]</b>	90

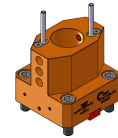

<b>Accessories</b>	N.A.
<b>Notes</b>	N.A.
<b>Mounting tips</b>	N.A.

Always check live tool dimensions on the turret

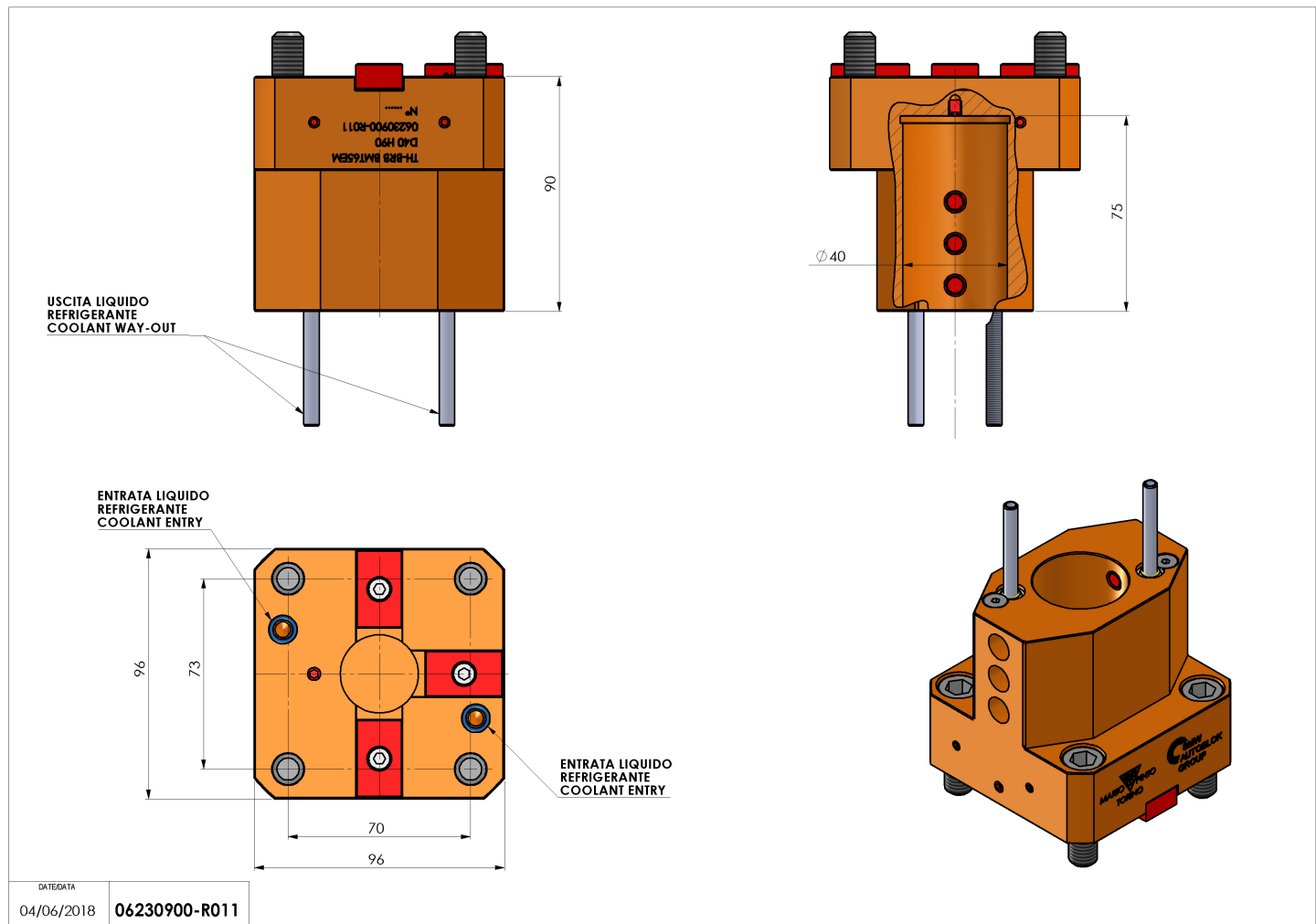

Subject to technical changes