

06230800 - TH-BRB BMT55EM D20 H75

Type	TH-BRB Boring bar holder
Mounting	BMT 55 EM
Tool output	Boring Bar Holder 20
Coolant	External / Internal coolant
H [mm]	75

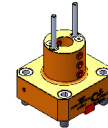

Accessories	N.A.
Notes	N.A.
Mounting tips	N.A.

Always check live tool dimensions on the turret

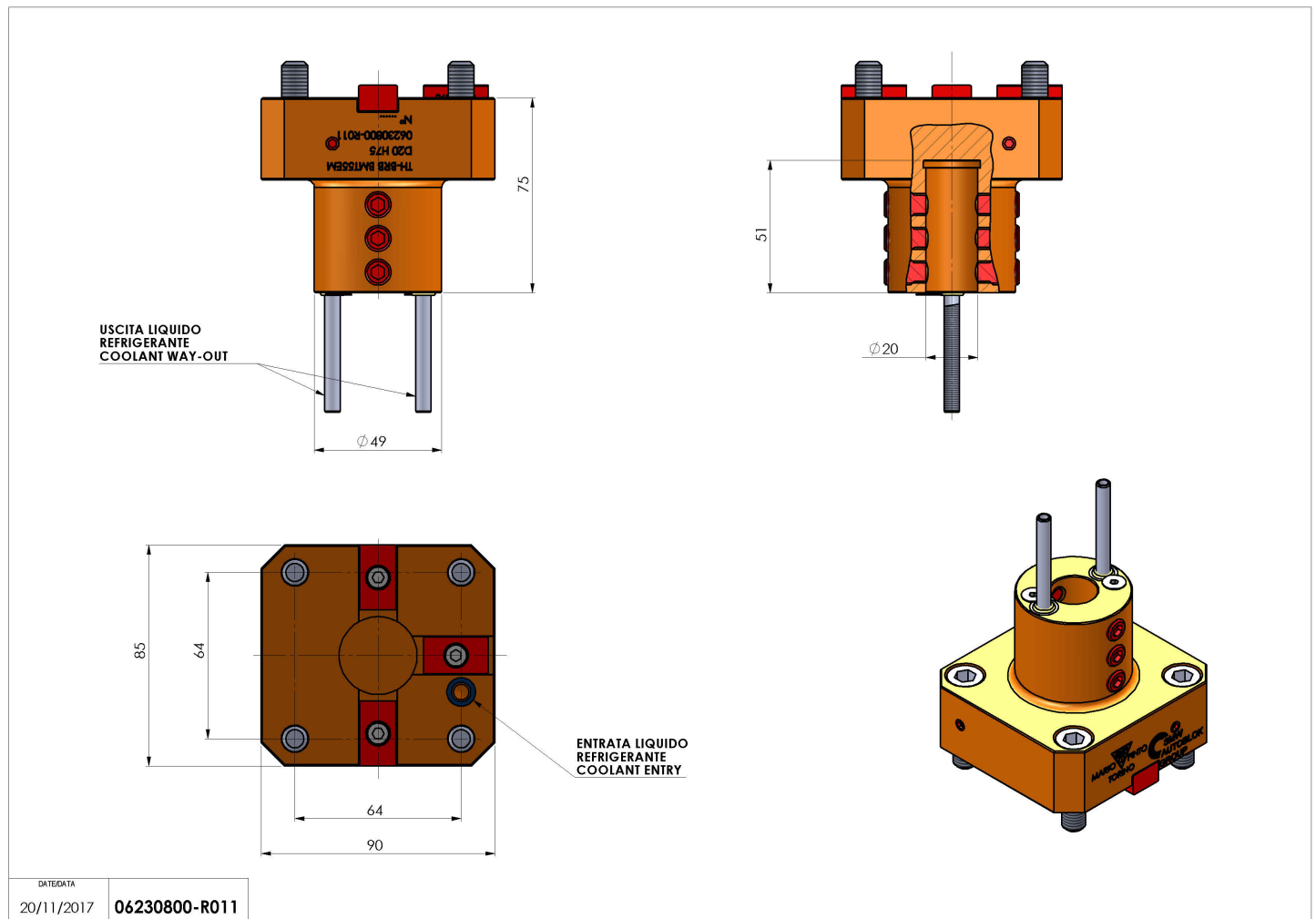

Subject to technical changes