

06156300 - TH-AX P18 C40 RF H130

Type	TH-AX Axial Tool holder
Mounting	CYLINDRICAL SHANK 55
Tool output	Polygonal shank C40 ISO 26623-1
Coolant	Internal coolant
H [mm]	130

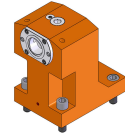

Accessories	N.A.
Notes	N.A.
Mounting tips	N.A.

Always check live tool dimensions on the turret

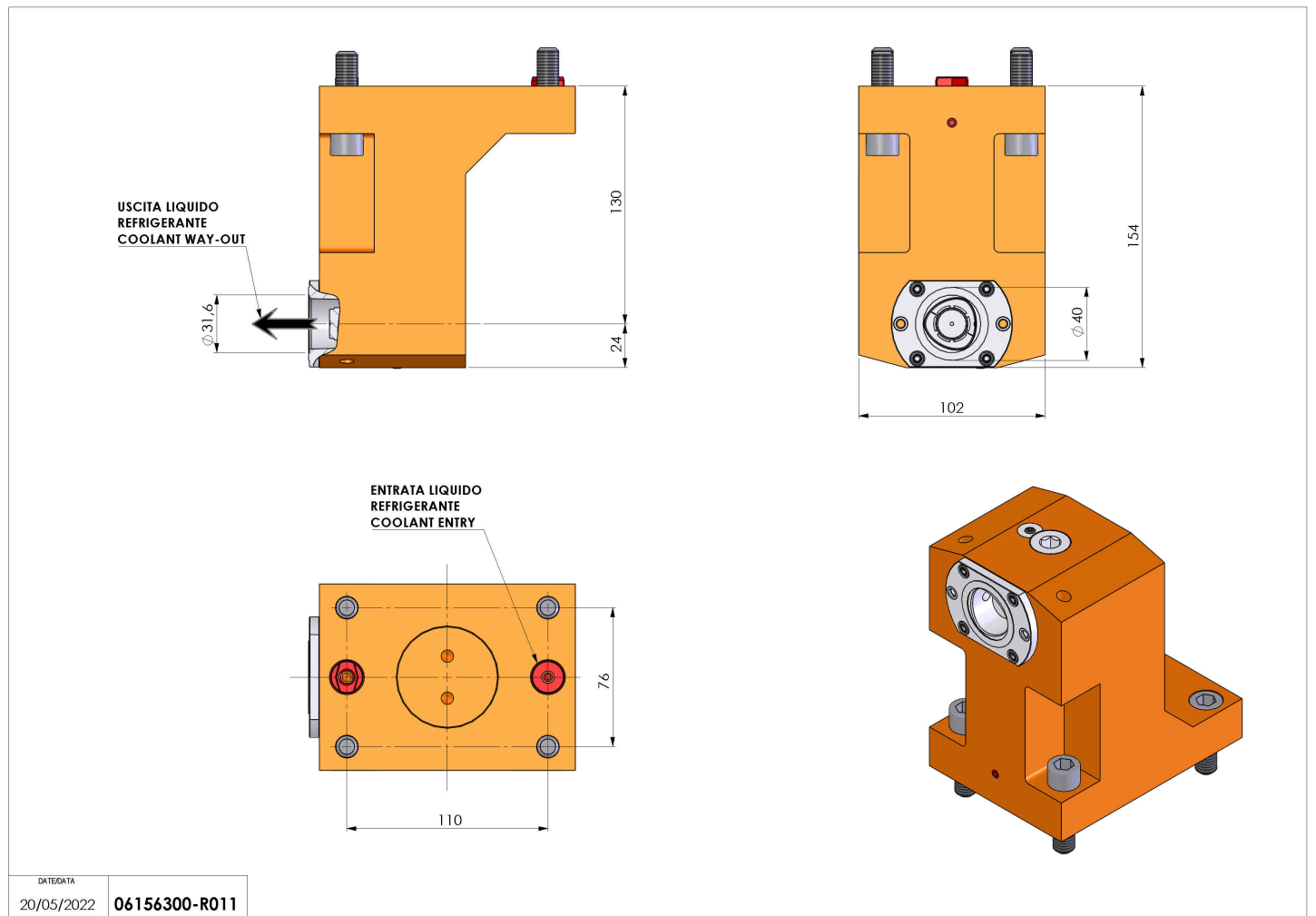

Subject to technical changes