

06064800 - TH-AX D60 C50 RF H90

Type	TH-AX Axial Tool holder
Mounting	CYLINDRICAL SHANK 60
Tool output	Polygonal shank C50 ISO 26623-1
Coolant	Internal coolant
H [mm]	90

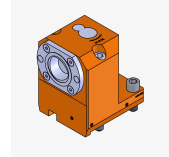

Accessories	N.A.
Notes	N.A.
Mounting tips	N.A.

Always check live tool dimensions on the turret

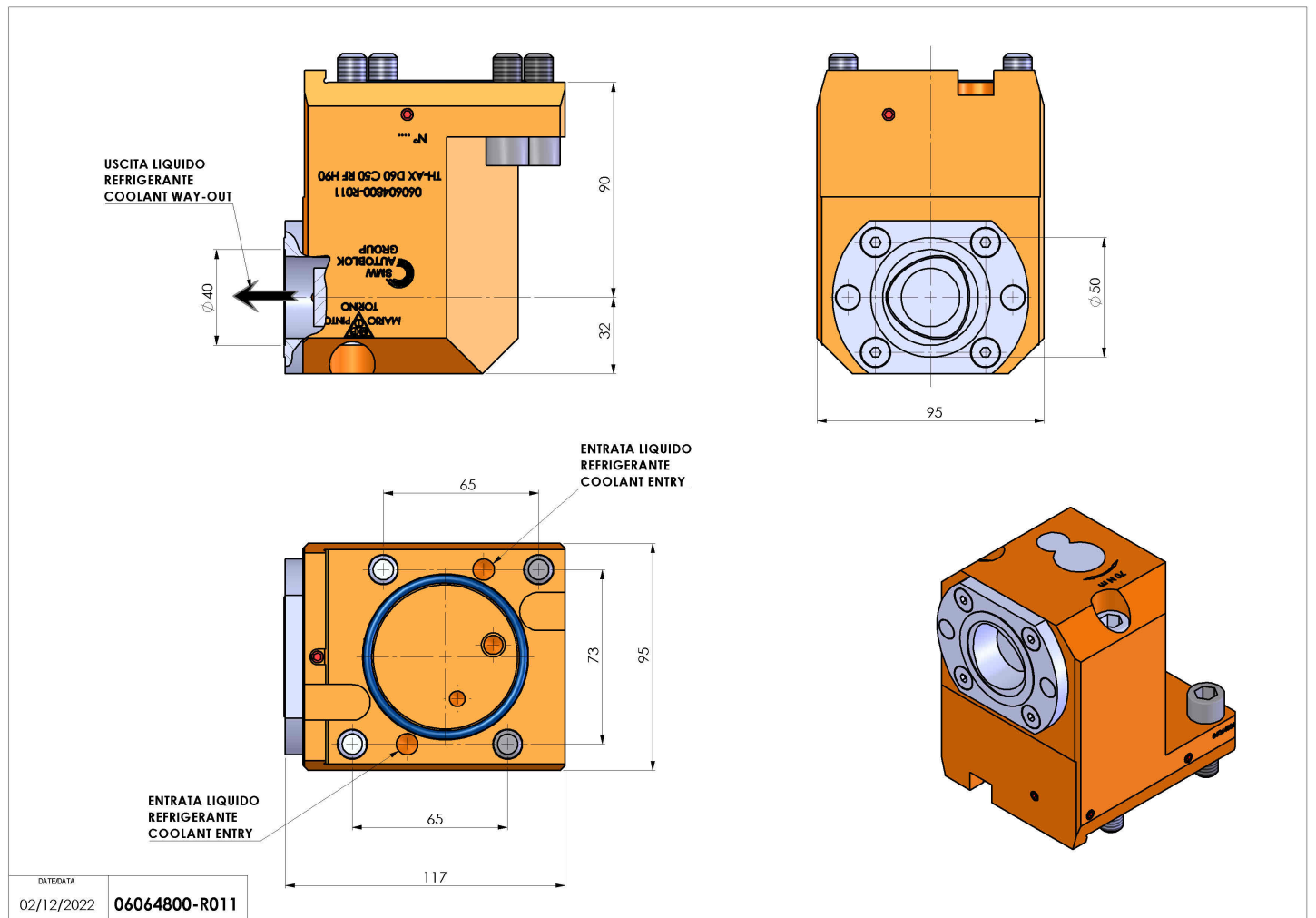

DATE/DATE	02/12/2022	06064800-R011
-----------	------------	---------------

Subject to technical changes