

06057100 - TH-RAD VDI40 H120 L80 DX MZ

Type	TH-RAD Radial Tool holder
Mounting	VDI 40
Tool output	Radial Square Tool Holder 25x25
Coolant	External coolant
H [mm]	120

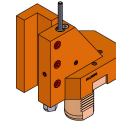

REPLACED BY 06057500

Accessories	N.A.
Notes	Soon out of stock. Replaced by cod. 06057500
Mounting tips	N.A.

ATTENTION: CHECK THE ORIENTATION OF THE VDI TEETH

Always check live tool dimensions on the turret

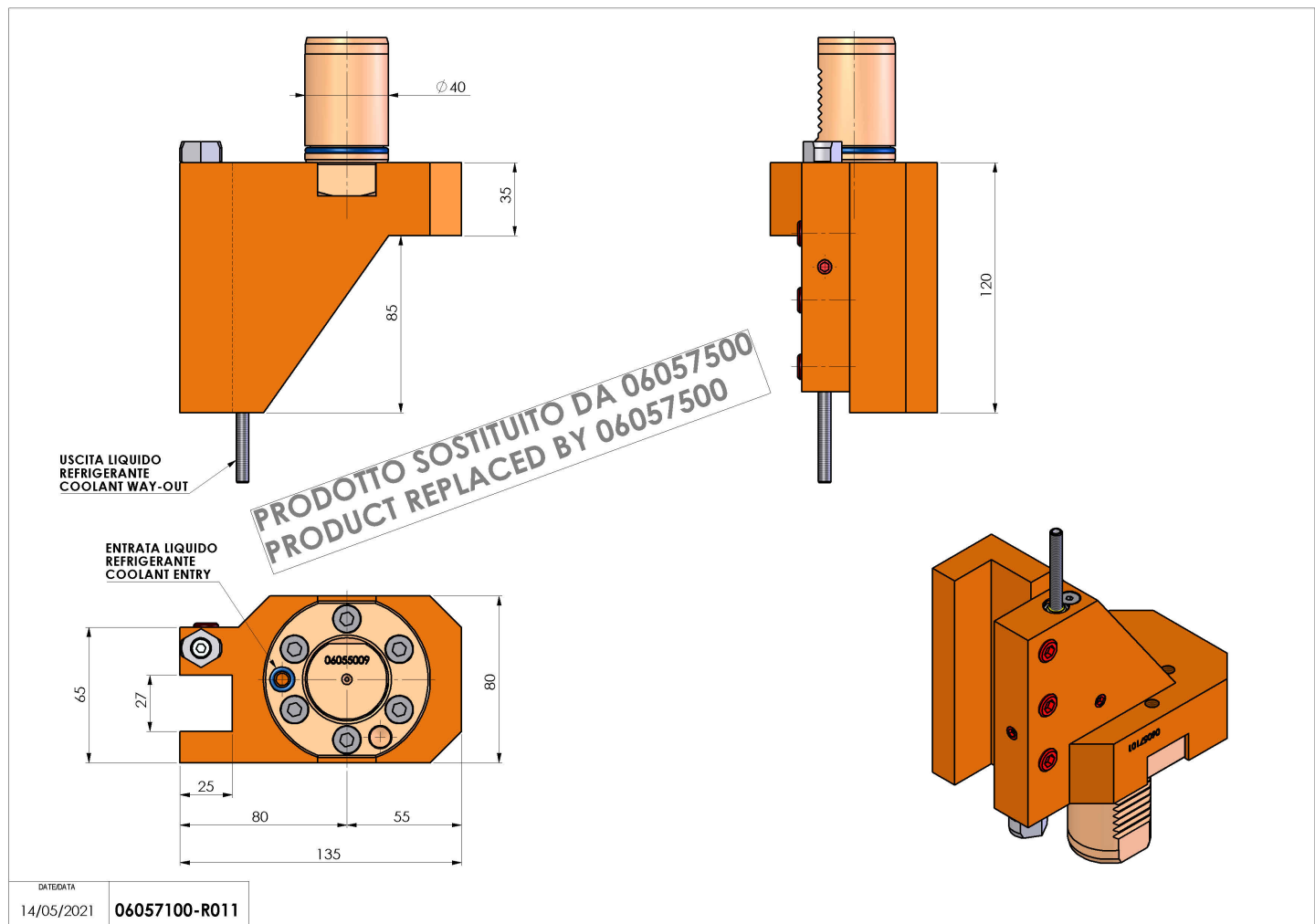

Subject to technical changes