

06052700 - TH-RENISHAW D11.3VDI40 68X15MZ

Type	TH Tool holder
Mounting	VDI 40
Tool output	Holder Presetting RENISHAW 11,3
Coolant	N.A.
H [mm]	25

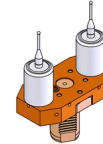

Accessories	N.A.
Notes	N.A.
Mounting tips	N.A.

ATTENTION: CHECK THE ORIENTATION OF THE VDI TEETH

Always check live tool dimensions on the turret

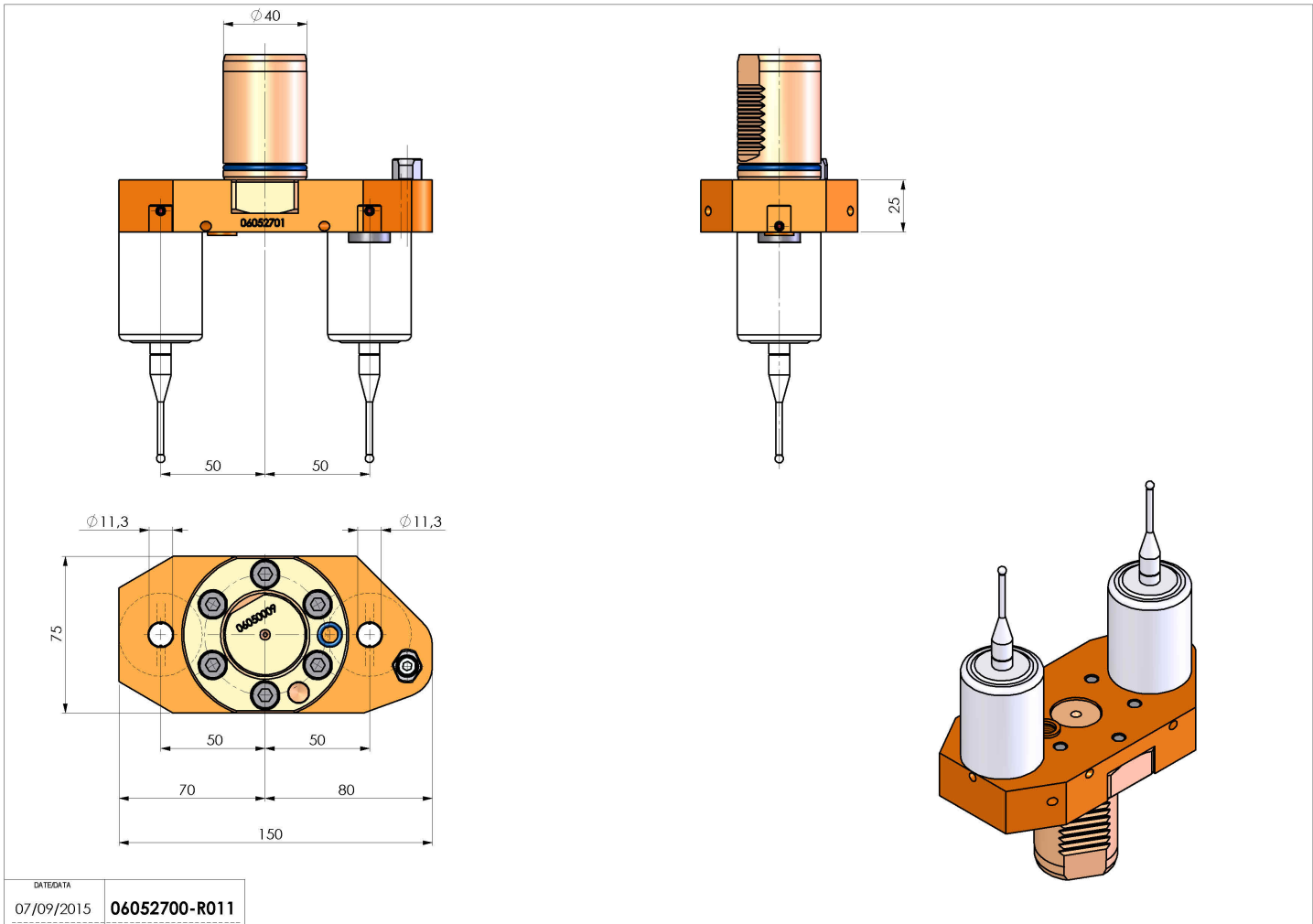

Subject to technical changes