

06051200 - TH-AX VDI40 H143 L92 DX-SX MZ

Type	TH-AX Axial Tool holder
Mounting	VDI 40
Tool output	Axial Square Tool Holder 25x25
Coolant	External coolant
H [mm]	143

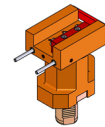

Accessories	N.A.
Notes	N.A.
Mounting tips	N.A.

ATTENTION: CHECK THE ORIENTATION OF THE VDI TEETH

Always check live tool dimensions on the turret

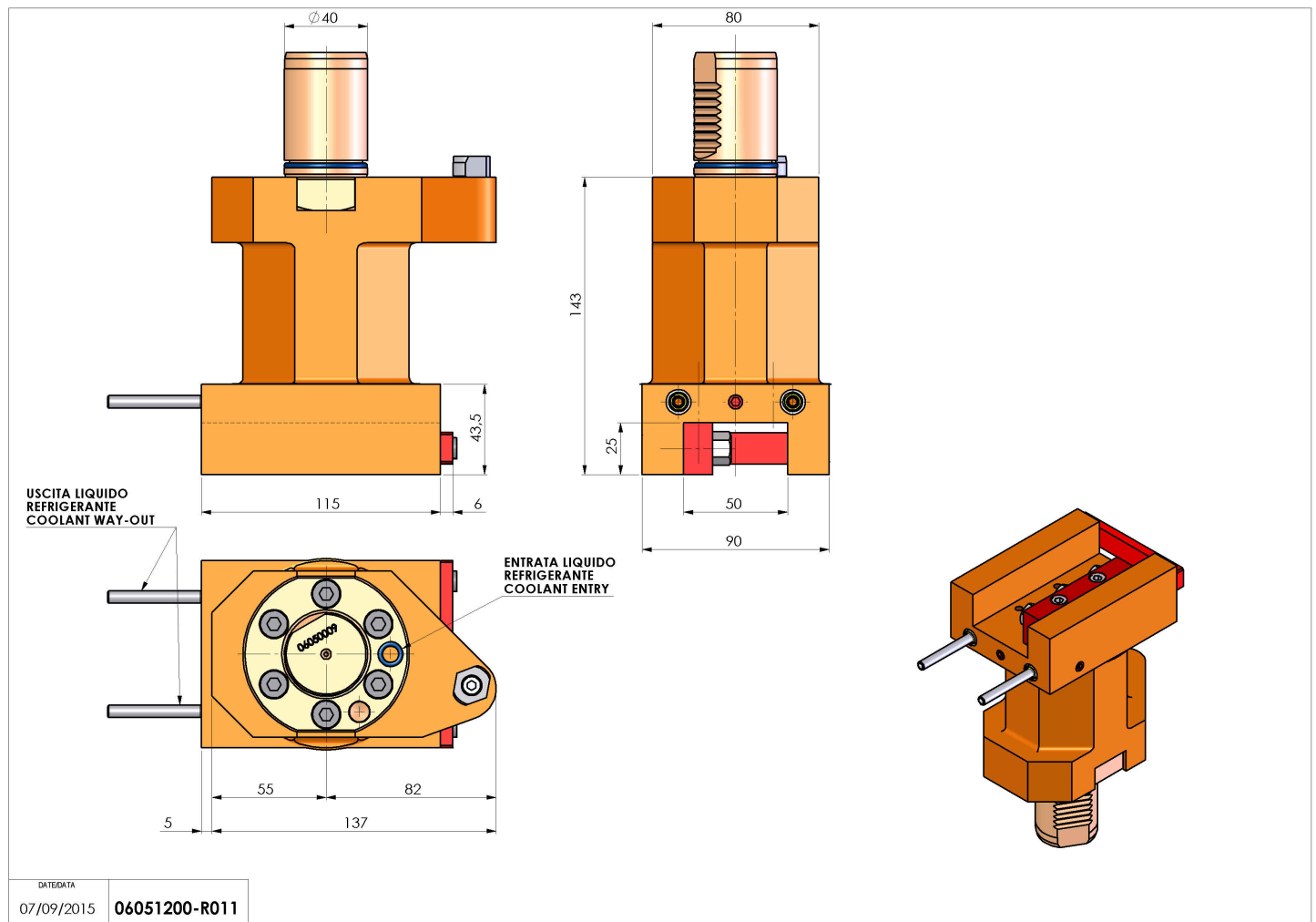

Subject to technical changes