

# 06050800 - TH-BRB VDI40 D25 H145 RF MZ

Type	TH-BRB Boring bar holder
Mounting	VDI 40
Tool output	Boring Bar Holder 25
Coolant	External / Internal coolant
H [mm]	145

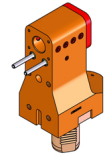

Accessories	N.A.
Notes	N.A.
Mounting tips	N.A.

**ATTENTION: CHECK THE ORIENTATION OF THE VDI TEETH**

Always check live tool dimensions on the turret

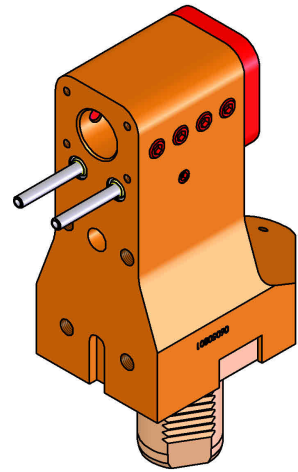
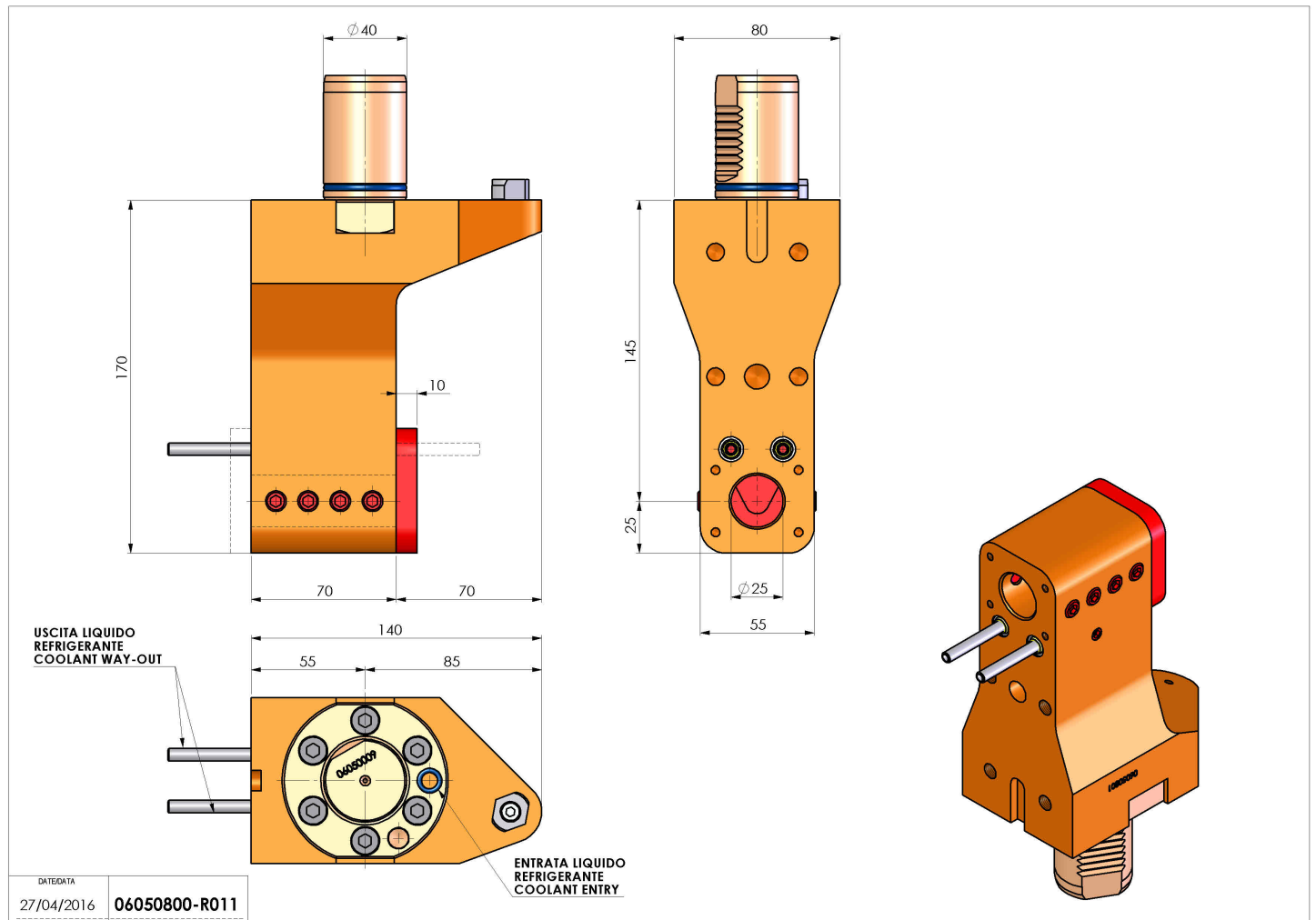

Subject to technical changes