

# 06050200 - TH-BRB VDI40 D40 H140 OFS RFMZ

<b>Type</b>	TH-BRB Boring bar holder
<b>Mounting</b>	VDI 40
<b>Tool output</b>	Boring Bar Holder 40
<b>Coolant</b>	External / Internal coolant
<b>H [mm]</b>	140

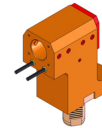

<b>Accessories</b>	N.A.
<b>Notes</b>	N.A.
<b>Mounting tips</b>	N.A.

**ATTENTION: CHECK THE ORIENTATION OF THE VDI TEETH**

Always check live tool dimensions on the turret

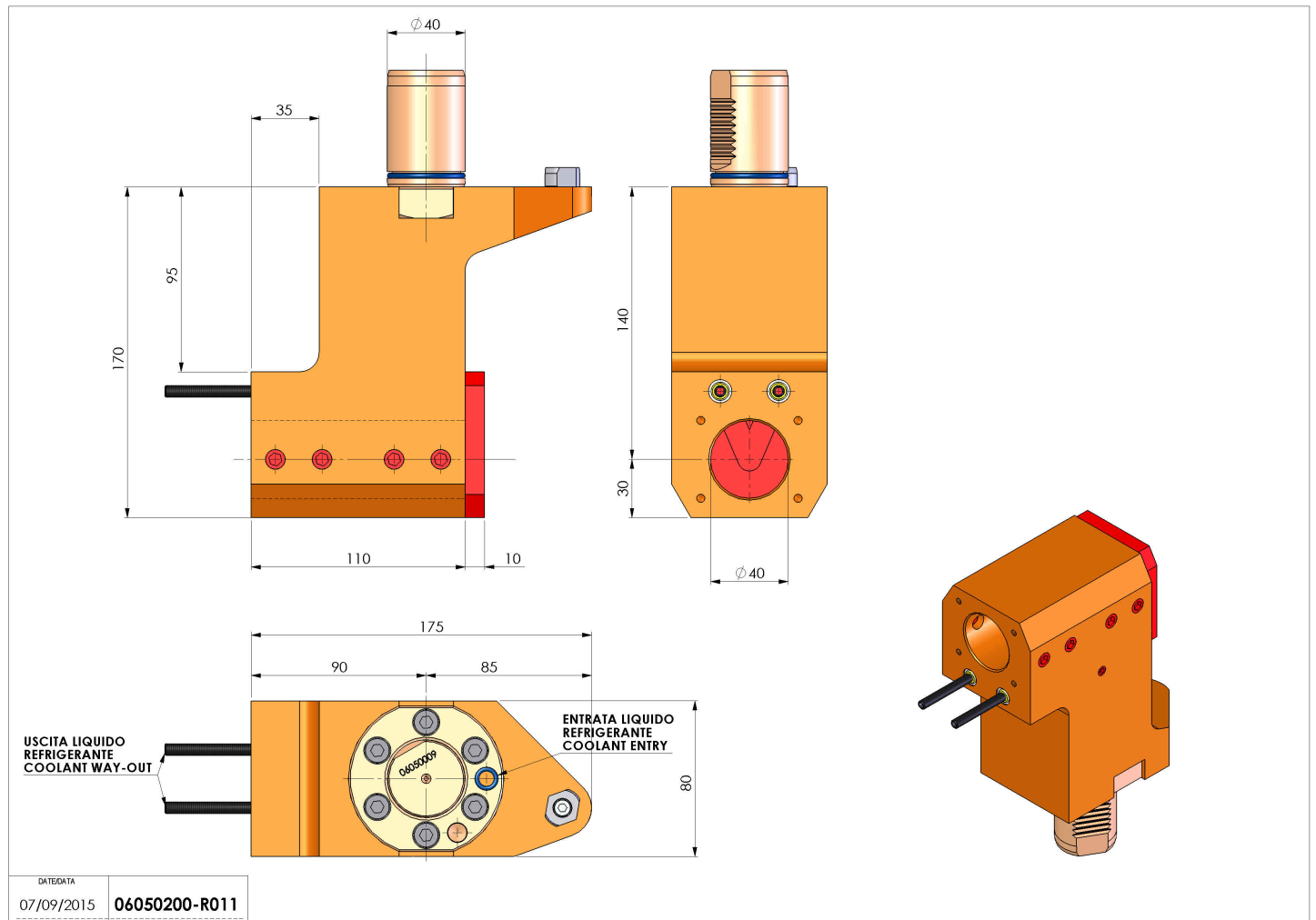

Subject to technical changes