

# 06043700 - TH-BRB D75 D50 H80 TAGL

|             |                             |
|-------------|-----------------------------|
| Type        | TH-BRB<br>Boring bar holder |
| Mounting    | CYLINDRICAL SHANK 75        |
| Tool output | Boring Bar Holder 50        |
| Coolant     | External coolant            |
| H [mm]      | 80                          |

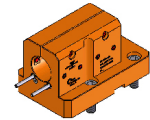

|               |                   |
|---------------|-------------------|
| Accessories   | N.A.              |
| Notes         | N.A.              |
| Mounting tips | Main spindle only |

Always check live tool dimensions on the turret

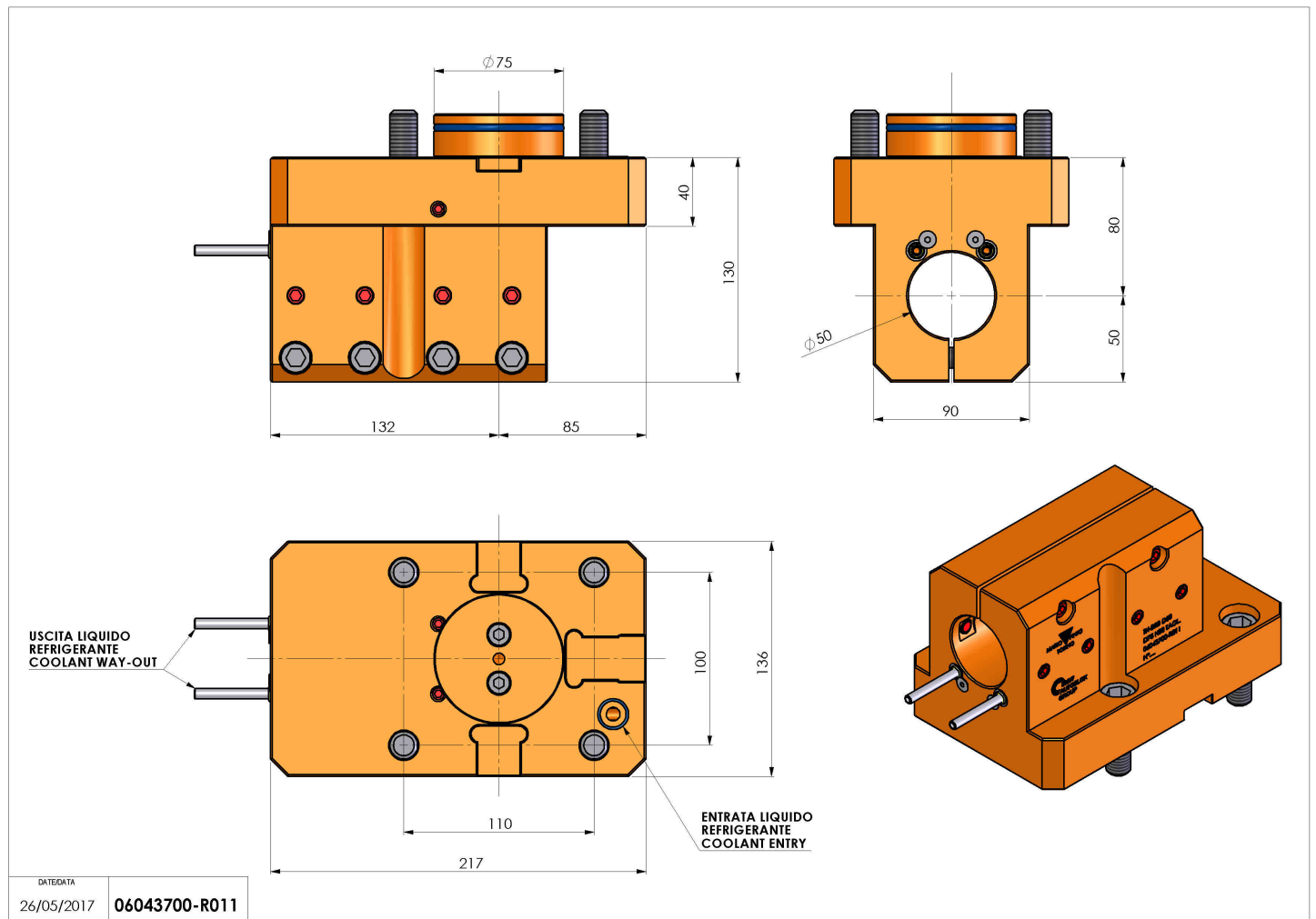

Subject to technical changes