

06043000 - TH-RAD D60 DP Q25 H77

Type	TH-RAD Radial Tool holder
Mounting	CYLINDRICAL SHANK 60
Tool output	Radial Square Tool Holder 25x25
Coolant	External coolant
H [mm]	77

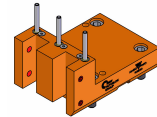

Accessories	N.A.
Notes	N.A.
Mounting tips	N.A.

Always check live tool dimensions on the turret

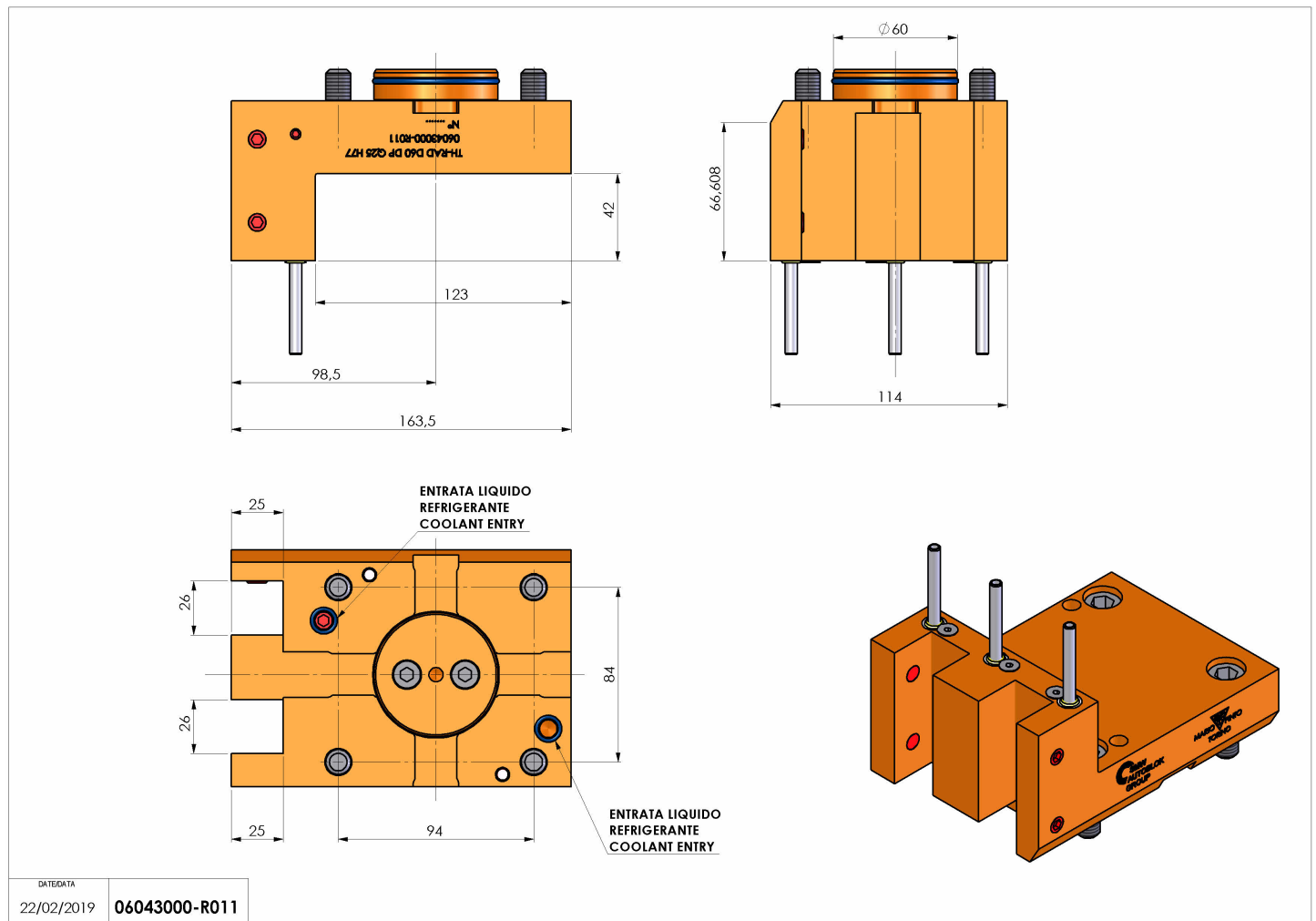

Subject to technical changes