

06040200 - TH-RAD D40 20X20 H70 MS

Type	TH-RAD Radial Tool holder
Mounting	CYLINDRICAL SHANK 40
Tool output	Radial Square Tool Holder 20x20
Coolant	External coolant
H [mm]	70

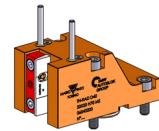

Accessories	N.A.
Notes	N.A.
Mounting tips	N.A.

Always check live tool dimensions on the turret

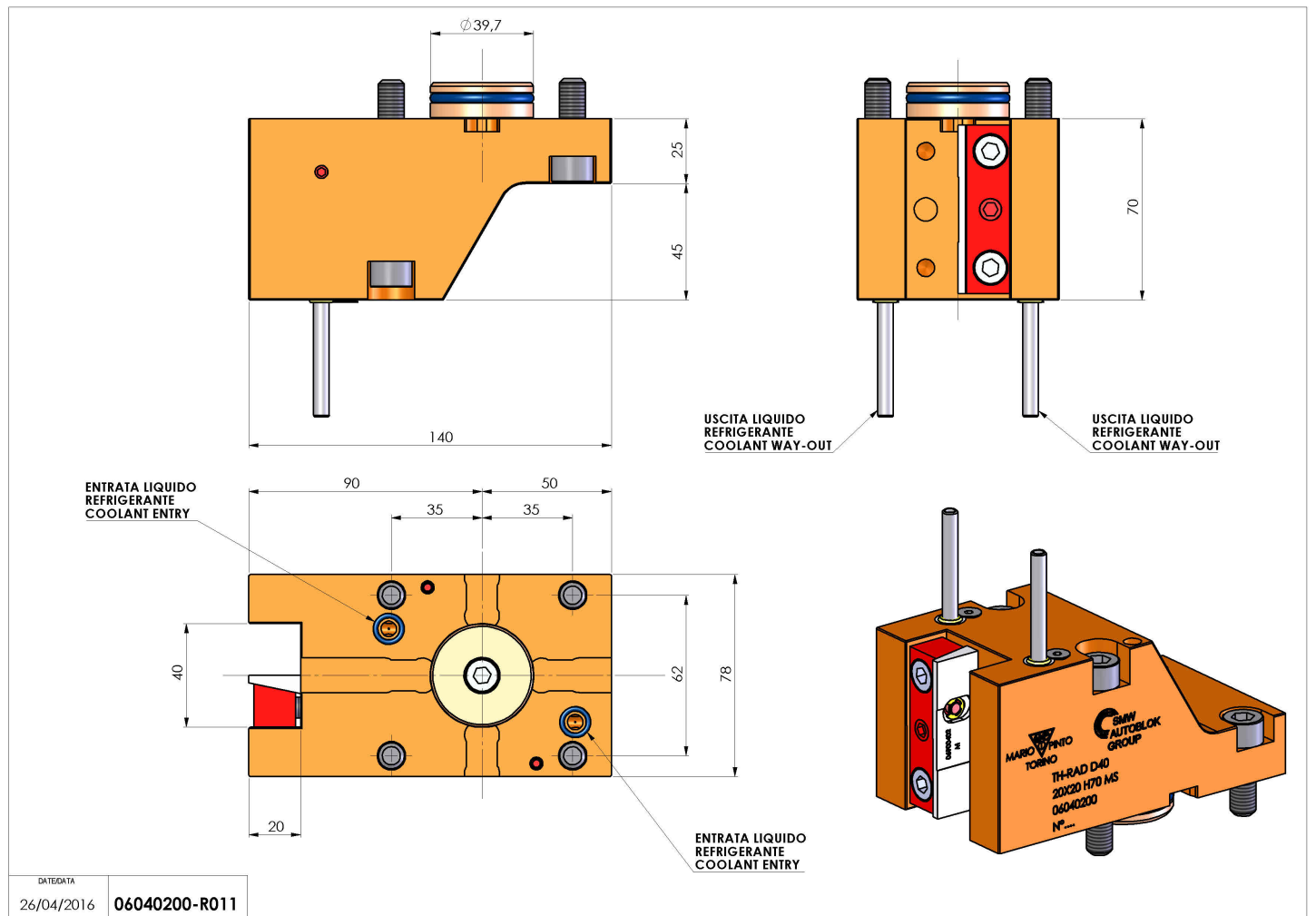

Subject to technical changes

DATE/DATE	26/04/2016	06040200-R011
-----------	------------	---------------