

06014100 - TH-CUT D65 SH32X3-5 TP H86

Type	TH-CUT Cutting holder
Mounting	CYLINDRICAL SHANK 65
Tool output	Cut Off Holder 32
Coolant	External coolant
H [mm]	86

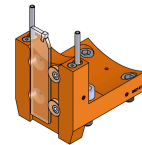

Accessories	N.A.
Notes	N.A.
Mounting tips	N.A.

Always check live tool dimensions on the turret

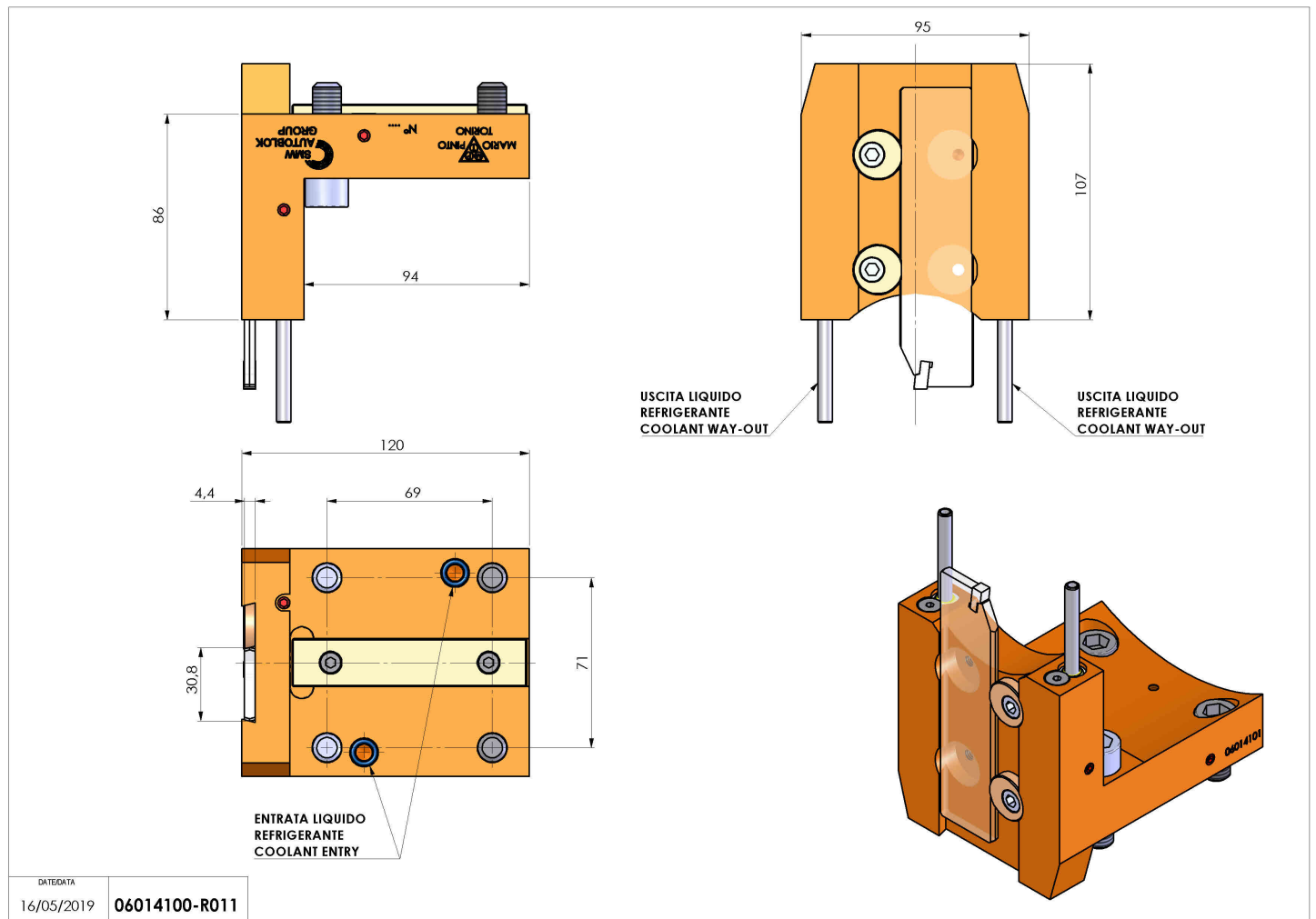

DATE/DATE	16/05/2019
06014100-R011	

Subject to technical changes