

## 06013600 - TH-AX D55 C40 RF H75

<b>Type</b>	TH-AX Axial Tool holder
<b>Mounting</b>	CYLINDRICAL SHANK 55
<b>Tool output</b>	Polygonal shank C40 ISO 26623-1
<b>Coolant</b>	Internal coolant
<b>H [mm]</b>	75
<b>Accessories</b>	N.A.
<b>Notes</b>	N.A.
<b>Mounting tips</b>	N.A.

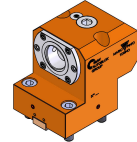

Always check live tool dimensions on the turret

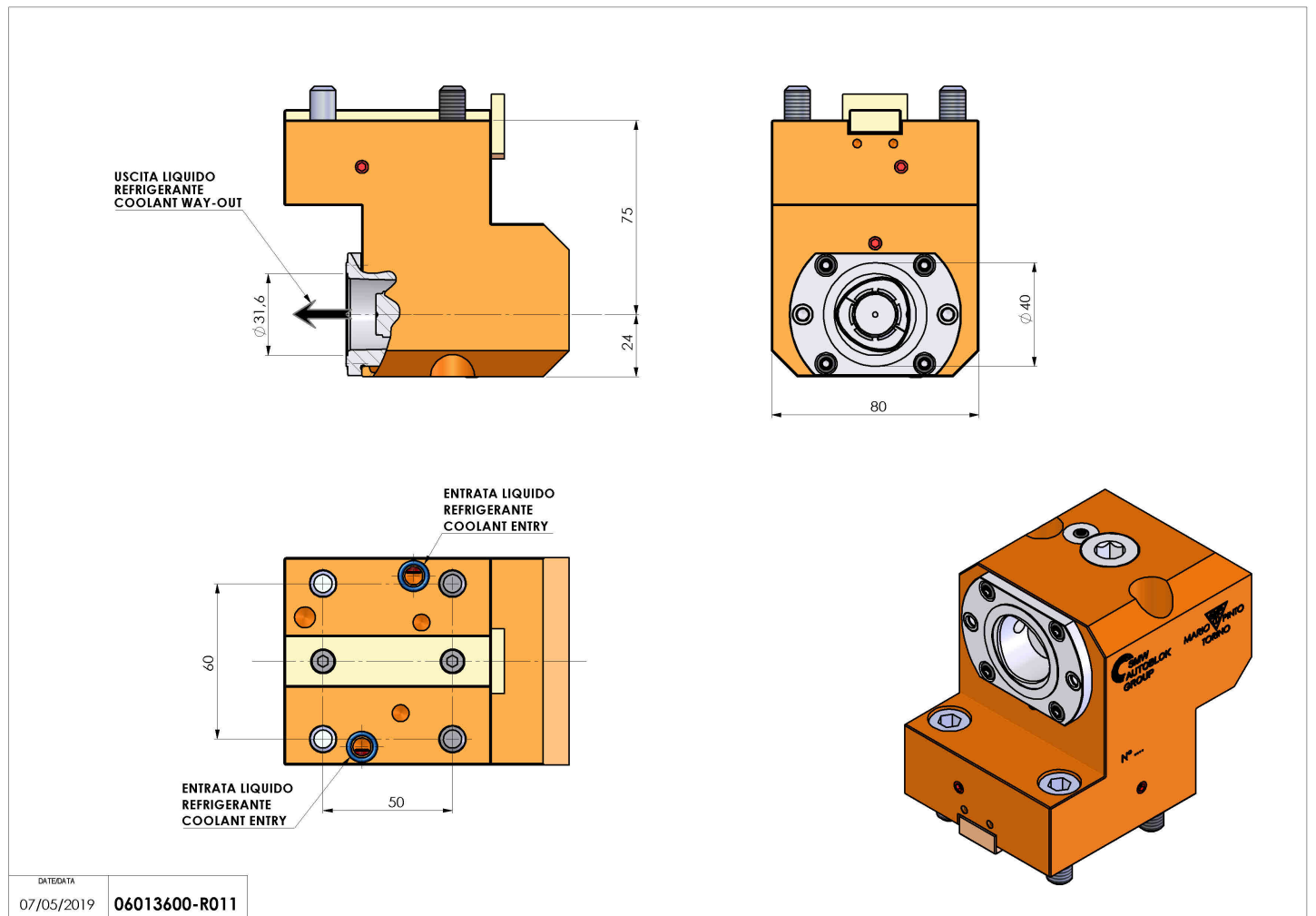

DATE/DATE	07/05/2019	06013600-R011
-----------	------------	---------------

Subject to technical changes