

05517700 - LT-S BMT85 BD ER40 H96

Type	LT-S Tool holder straight
Mounting	BMT 85 BIG DRIVE
Tool output	Collet nut ER 40
Coolant	External coolant
Direction of rotation	r1 r2
Max speed [rpm]	4000
Max torque [Nm]	100
Ratio	1:1
H [mm]	96
Accessories	N.A.
Notes	N.A.
Mounting tips	N.A.

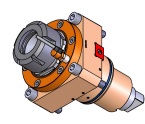

Always check live tool dimensions on the turret

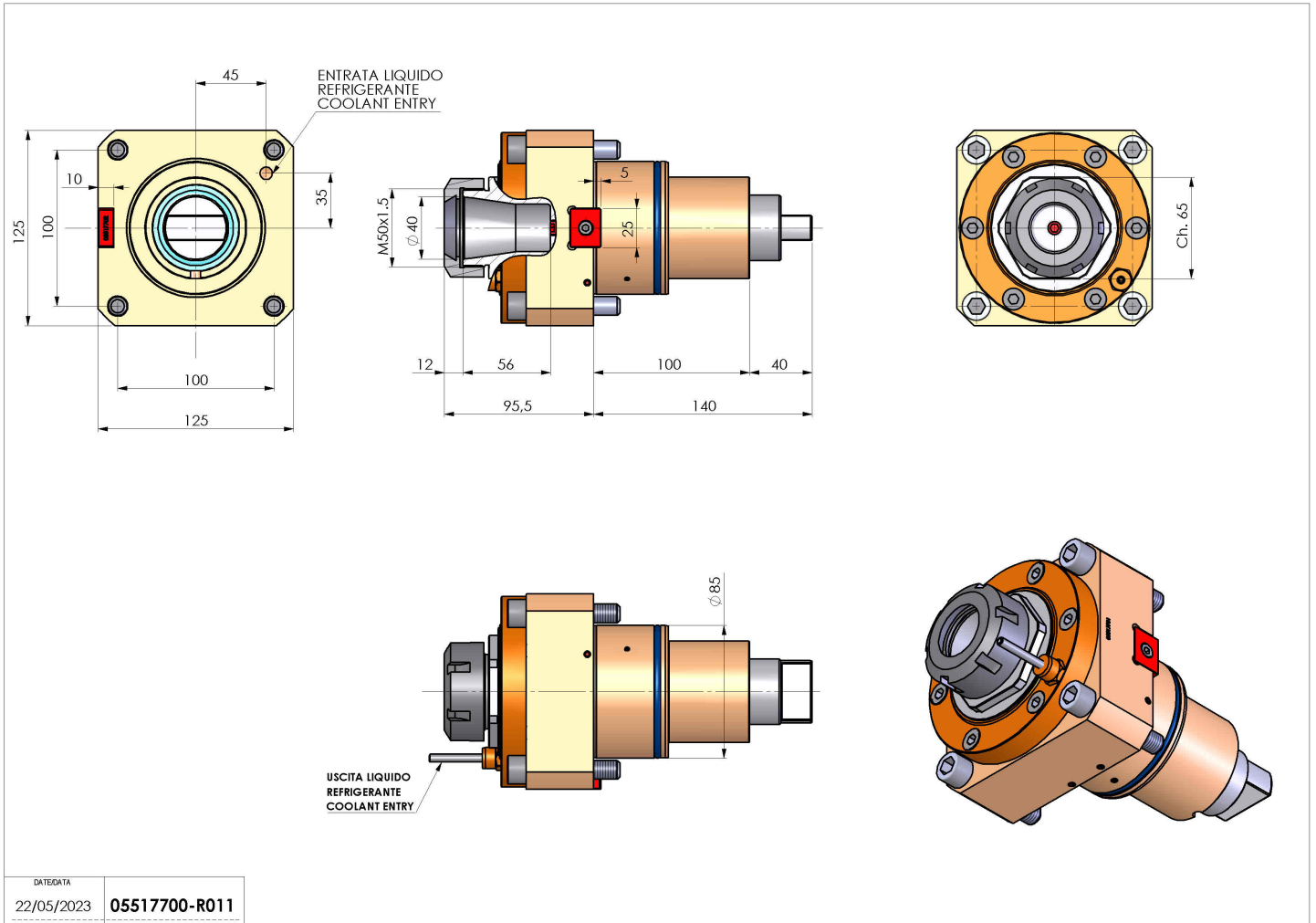

DATE/DATE	
22/05/2023	05517700-R011

Subject to technical changes