

## 05482600 - LT-S VDI40 ER40F H94

Type	LT-S Tool holder straight
Mounting	VDI 40
Tool output	Collet nut ER 40 F - internal nut
Coolant	External coolant
Direction of rotation	r1 ↻ r2 ↻
Max speed [rpm]	8000
Max torque [Nm]	80
Ratio	1:1
H [mm]	94
Accessories	N.A.
Notes	N.A.
Mounting tips	N.A.

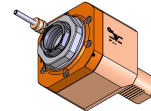

**ATTENTION: CHECK THE ORIENTATION OF THE VDI TEETH**

Always check live tool dimensions on the turret

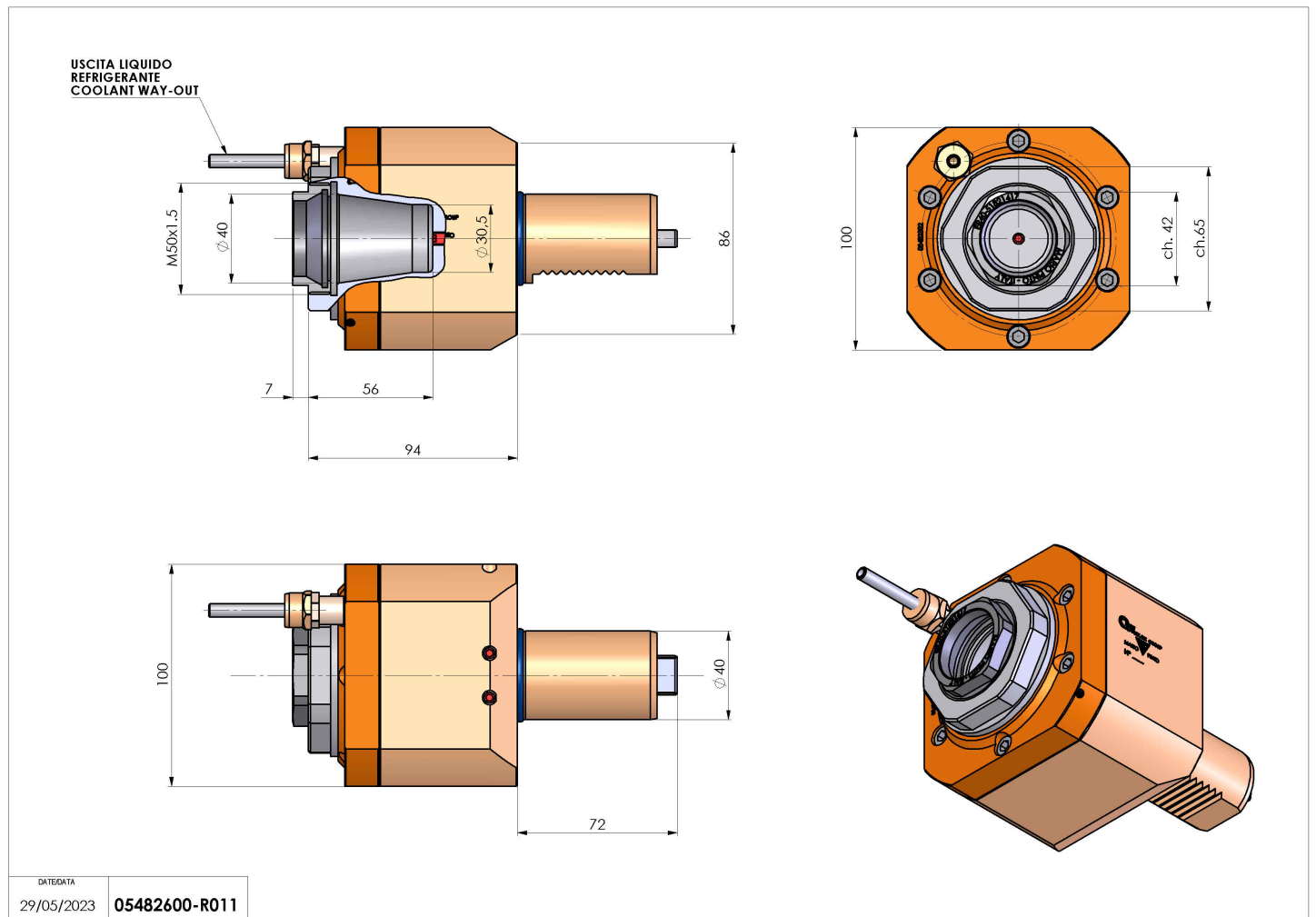

DATE/DATA  
29/05/2023 05482600-R011

Subject to technical changes