

05401900 - LT-A D60 ER32 LR H90

Type	LT-A Tool holder angle 90°
Mounting	CYLINDRICAL SHANK 60
Tool output	Collet nut ER 32
Coolant	External coolant
Direction of rotation	r1 ↻ r2 ↻
Max speed [rpm]	6000
Max torque [Nm]	70
Ratio	1:1
H [mm]	90
Accessories	N.A.
Notes	N.A.
Mounting tips	N.A.

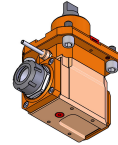

Always check live tool dimensions on the turret

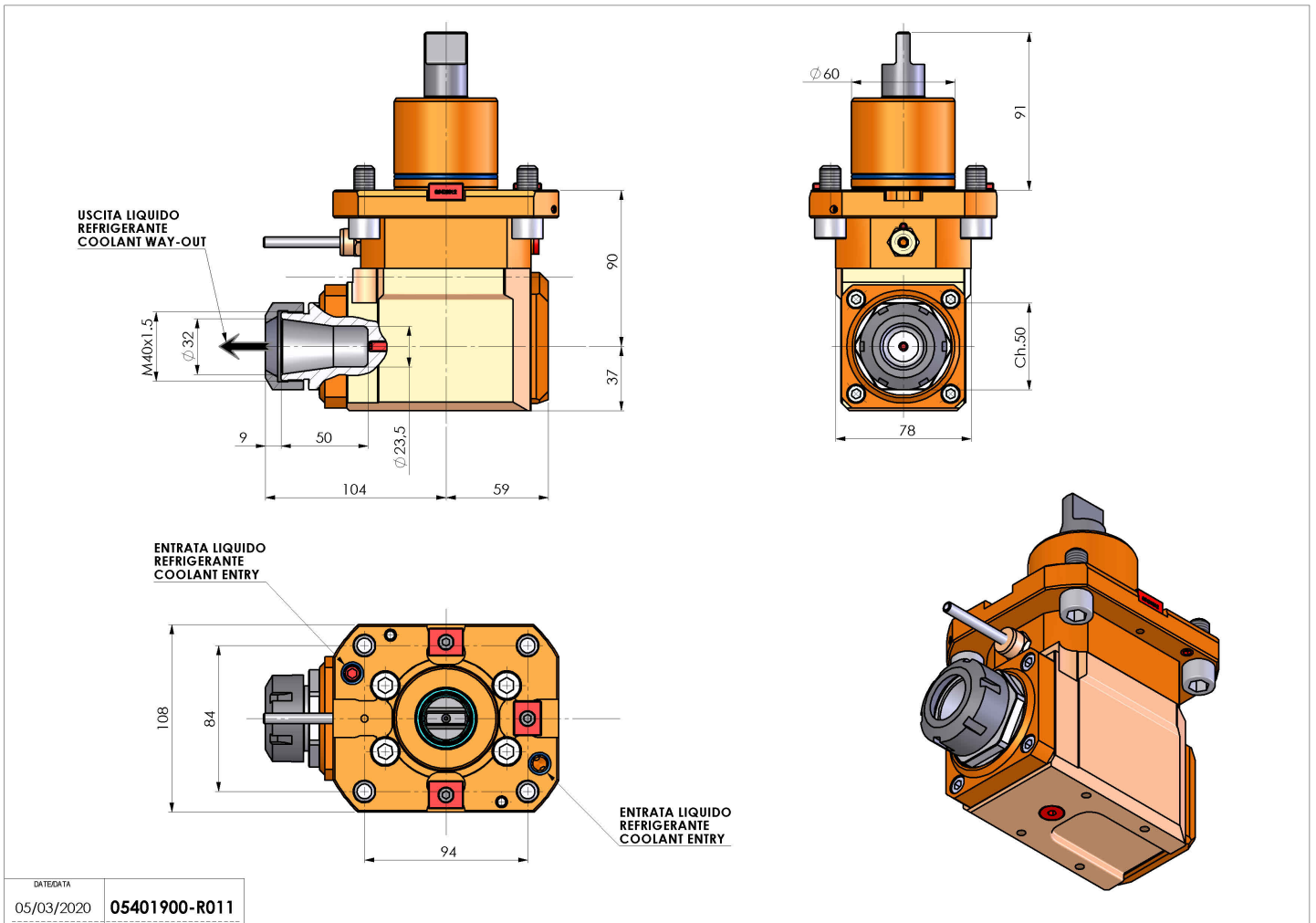

Subject to technical changes