



05400700 - LT-S D60 ER40F HRF H95

Type	LT-S Tool holder straight
Mounting	CYLINDRICAL SHANK 60
Tool output	Collet nut ER 40 F - internal nut
Coolant	HRF Internal coolant
Direction of rotation	r1  r2 
Max speed [rpm]	6000
Max torque [Nm]	70
Ratio	1:1
H [mm]	95
Max pressure [bar]	70
Accessories	N.A.
Notes	N.A.
Mounting tips	N.A.



Always check live tool dimensions on the turret

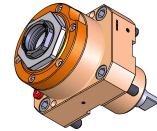
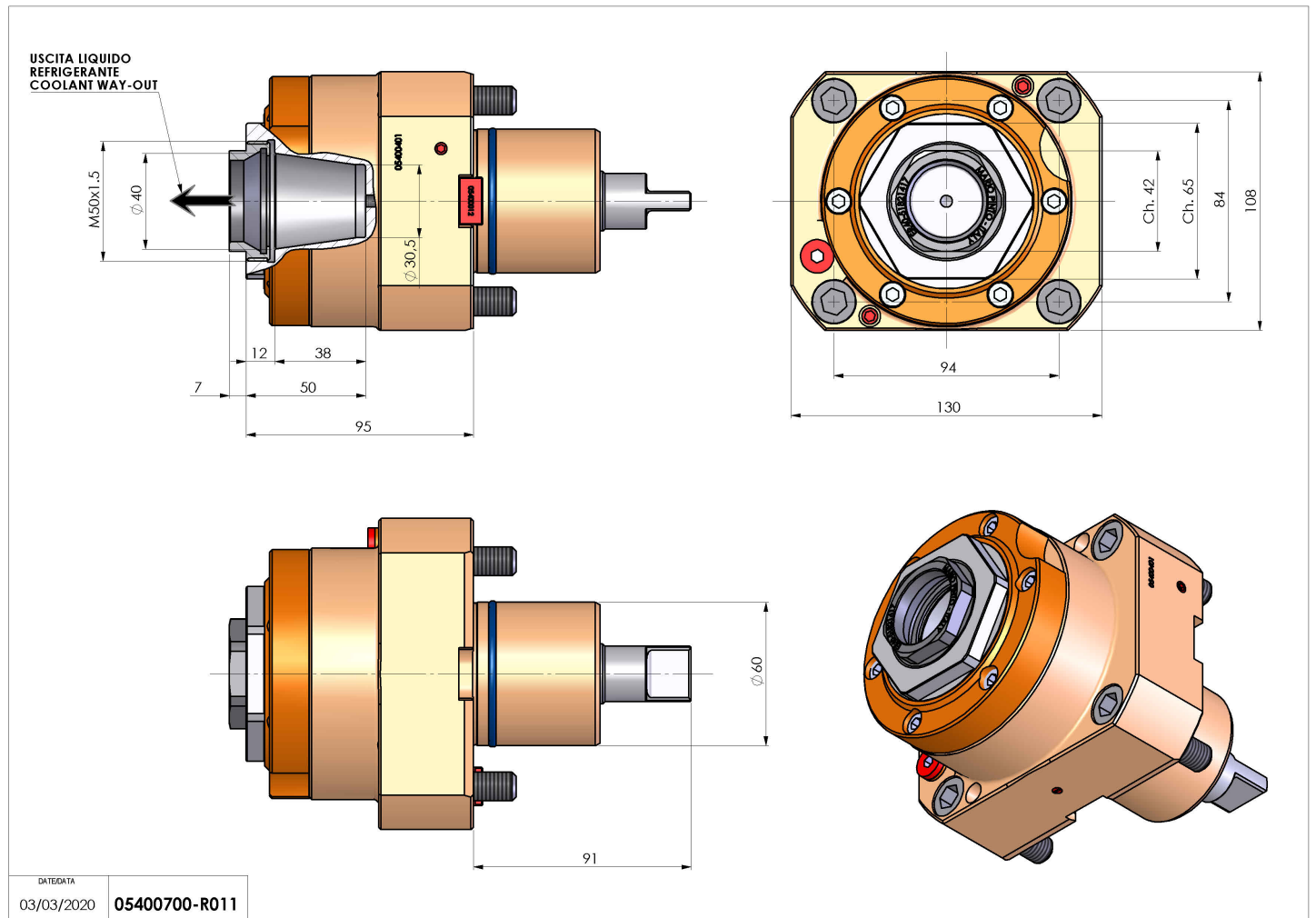

Subject to technical changes