

05372700 - LT-HOB-SAW D55 L60 1:1 H80

Type	LT-HOB-SAW Hobbing/tool holder saw
Mounting	CYLINDRICAL SHANK 55
Tool output	Shank kit Ø16-Ø22-Ø27
Coolant	External coolant
Max speed [rpm]	6000
Max torque [Nm]	60
Ratio	1:1
H [mm]	80
H1 [mm]	40
Accessories	N.A.
Notes	N.A.
Mounting tips	N.A.

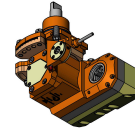

Always check live tool dimensions on the turret

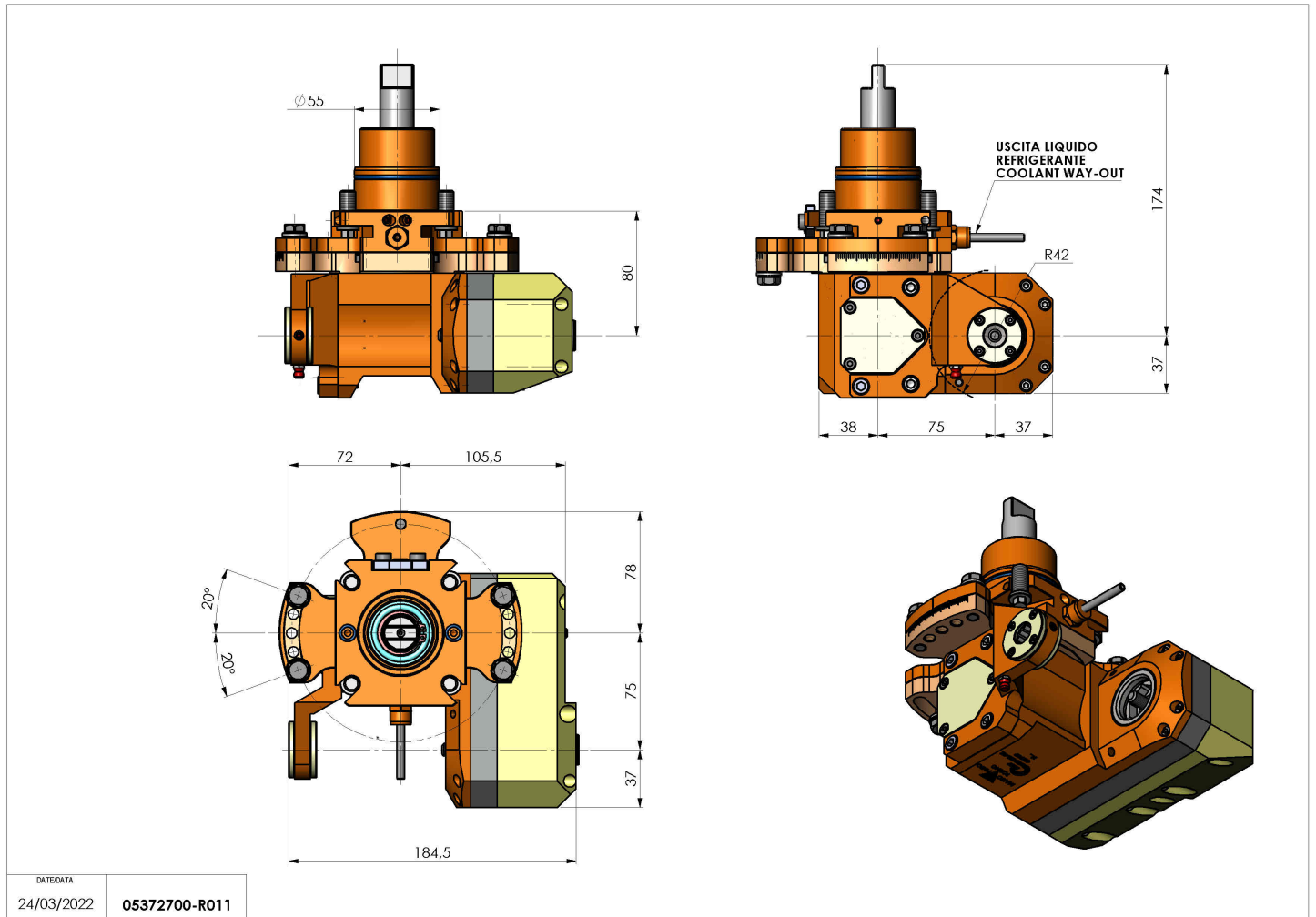

Subject to technical changes