

## 05351100 - LT-A D68 WELDON12 H80 MZ

<b>Type</b>	LT-A Tool holder angle 90°
<b>Mounting</b>	CYLINDRICAL SHANK 68
<b>Tool output</b>	Weldon 12 DIN1835B
<b>Coolant</b>	External coolant
<b>Direction of rotation</b>	r1 ↻ r2 ↻
<b>Max speed [rpm]</b>	6000
<b>Max torque [Nm]</b>	63
<b>Ratio</b>	1:1
<b>H [mm]</b>	80
<b>H1 [mm]</b>	38
<b>Accessories</b>	N.A.
<b>Notes</b>	N.A.
<b>Mounting tips</b>	Main spindle only

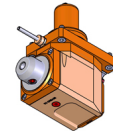

Always check live tool dimensions on the turret

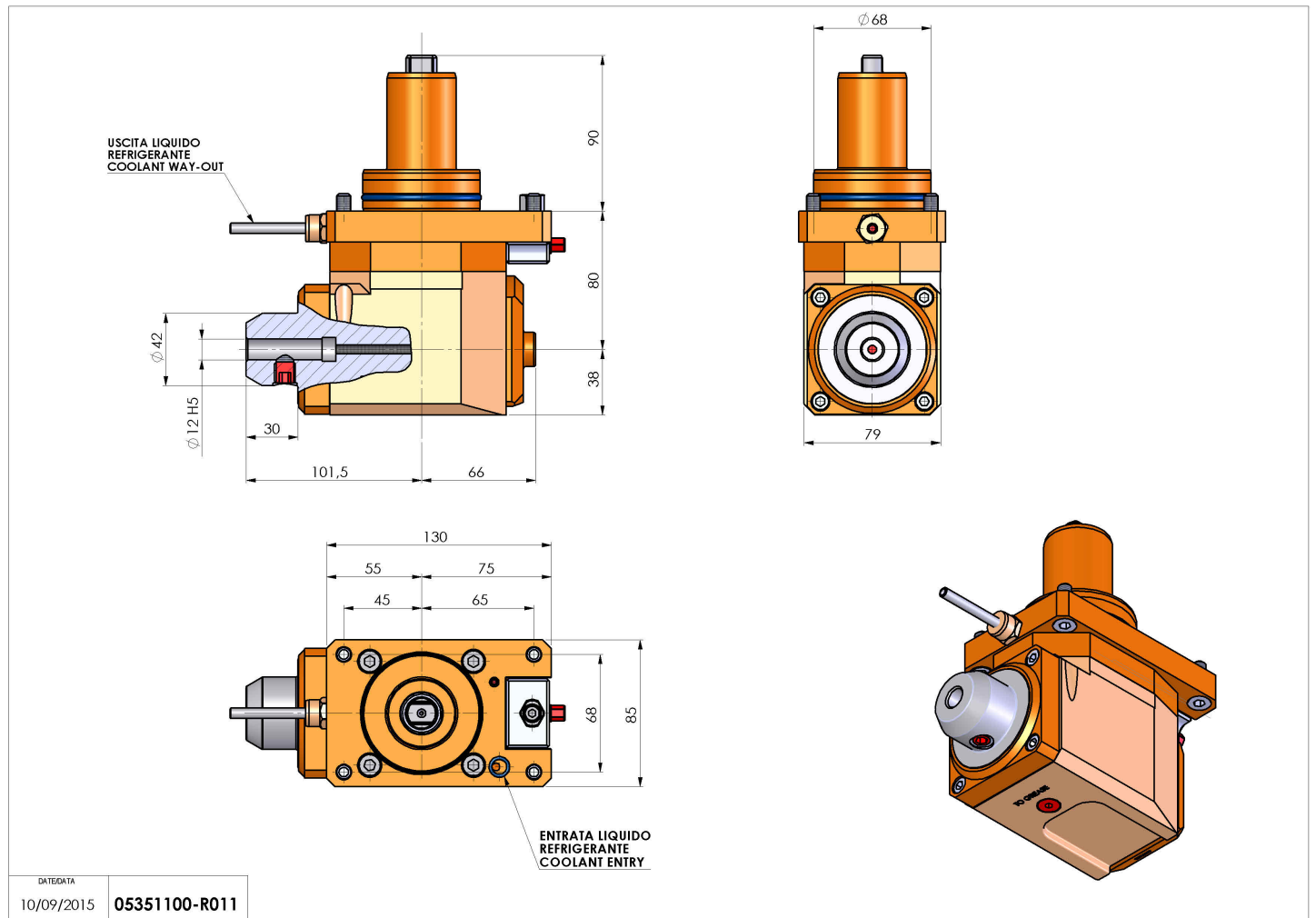

DATE/DATE  
10/09/2015 05351100-R011

Subject to technical changes