

# 05328400 - LT-A BMT55 ER32 LR HRF H60

Type	LT-A Tool holder angle 90°
Mounting	BMT 55
Tool output	Collet nut ER 32
Coolant	HRF Internal coolant
Direction of rotation	r1 ↻ r2 ↻
Max speed [rpm]	6000
Max torque [Nm]	40
Ratio	1:1
H [mm]	60
H1 [mm]	32.5
Max pressure [bar]	80
Accessories	N.A.
Notes	N.A.
Mounting tips	N.A.

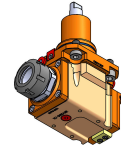

Always check live tool dimensions on the turret

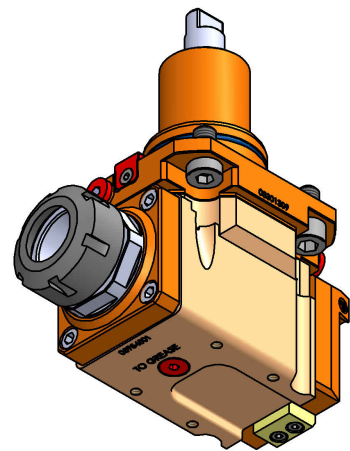
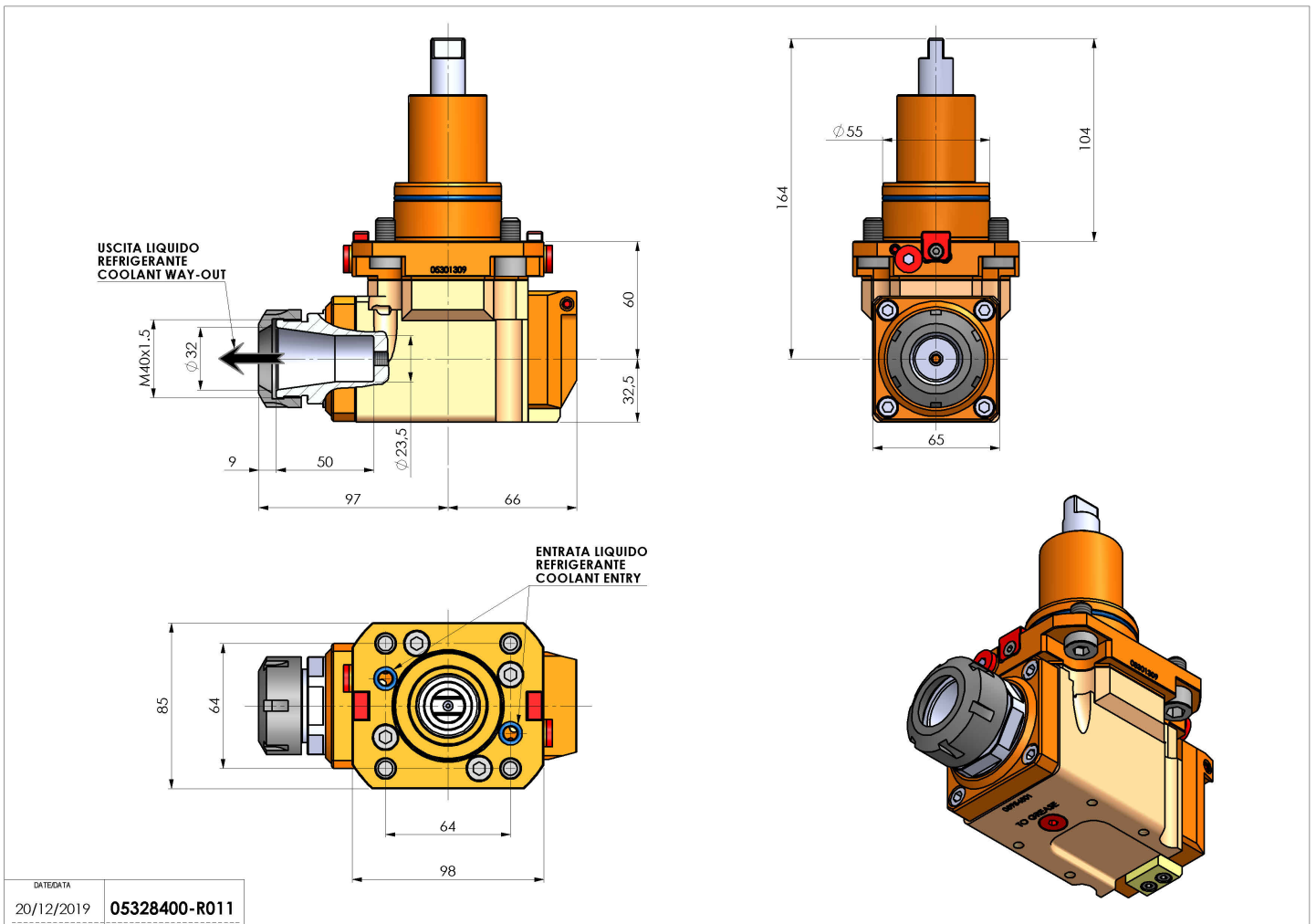

Subject to technical changes

DATE/DATE  
20/12/2019 05328400-R011