

## 05311200 - LT-S BMT55 BD ER25F H58

<b>Type</b>	LT-S Tool holder straight
<b>Mounting</b>	BMT 55 BIG DRIVE
<b>Tool output</b>	Collet nut ER 25 F - internal nut
<b>Coolant</b>	External coolant
<b>Direction of rotation</b>	r1  r2
<b>Max speed [rpm]</b>	6000
<b>Max torque [Nm]</b>	60
<b>Ratio</b>	1:1
<b>H [mm]</b>	58
<b>Accessories</b>	N.A.
<b>Notes</b>	N.A.
<b>Mounting tips</b>	N.A.

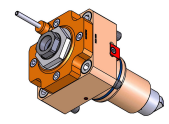

Always check live tool dimensions on the turret

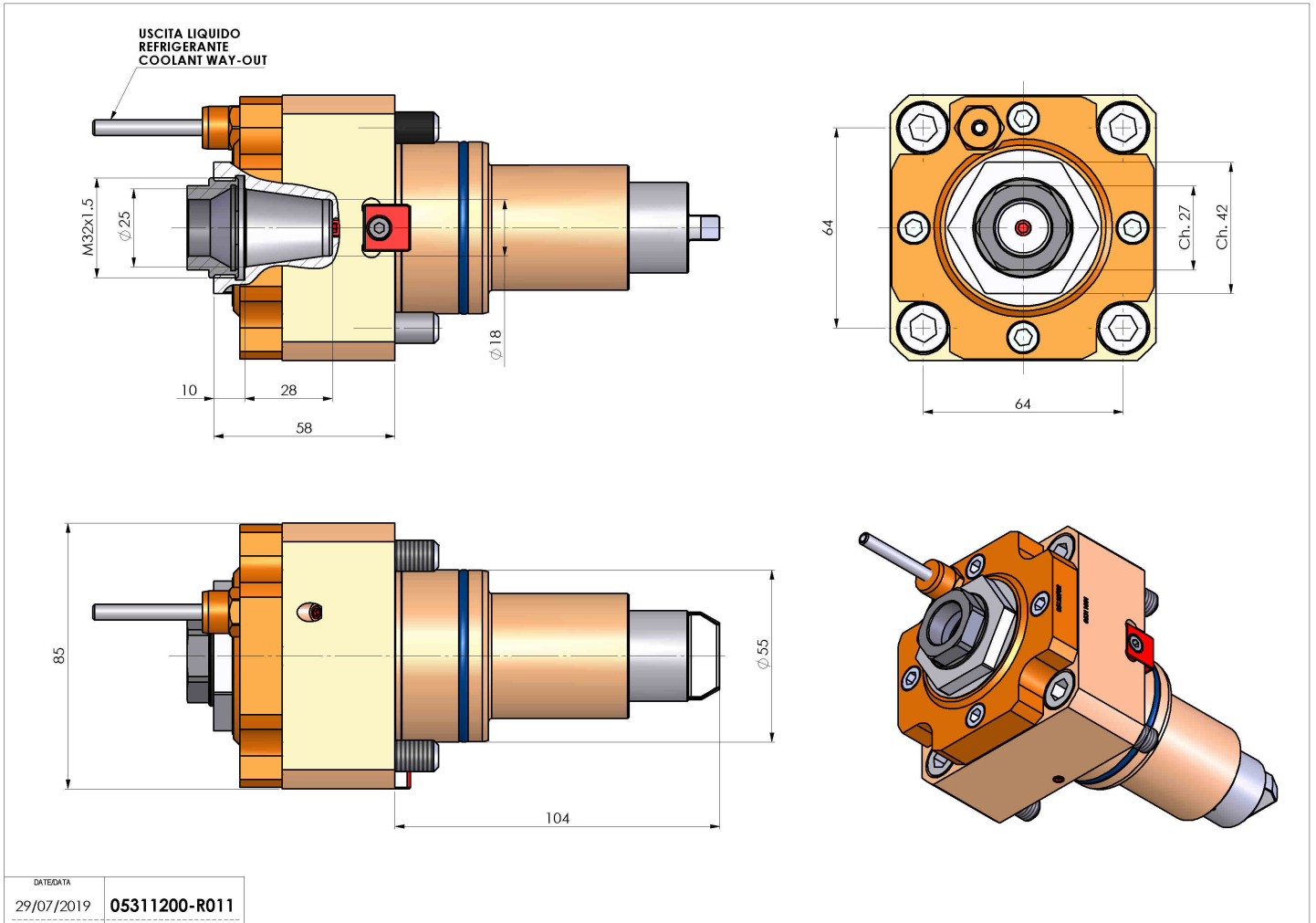

DATE/DATE	
29/07/2019	05311200-R011

**Subject to technical changes**