

# 05305000 - LT-A BMT75 ER50 LR RF 2:1 H90

<b>Type</b>	LT-A Tool holder angle 90°
<b>Mounting</b>	BMT 75
<b>Tool output</b>	Collet nut ER 50
<b>Coolant</b>	Internal coolant
<b>Direction of rotation</b>	r1  r2
<b>Max speed [rpm]</b>	in 4000 / out 2000
<b>Max torque [Nm]</b>	in 60 / out 120
<b>Ratio</b>	2:1
<b>H [mm]</b>	90
<b>H1 [mm]</b>	52
<b>Max pressure [bar]</b>	20
<b>Accessories</b>	N.A.
<b>Notes</b>	N.A.
<b>Mounting tips</b>	N.A.

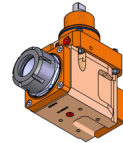

Always check live tool dimensions on the turret

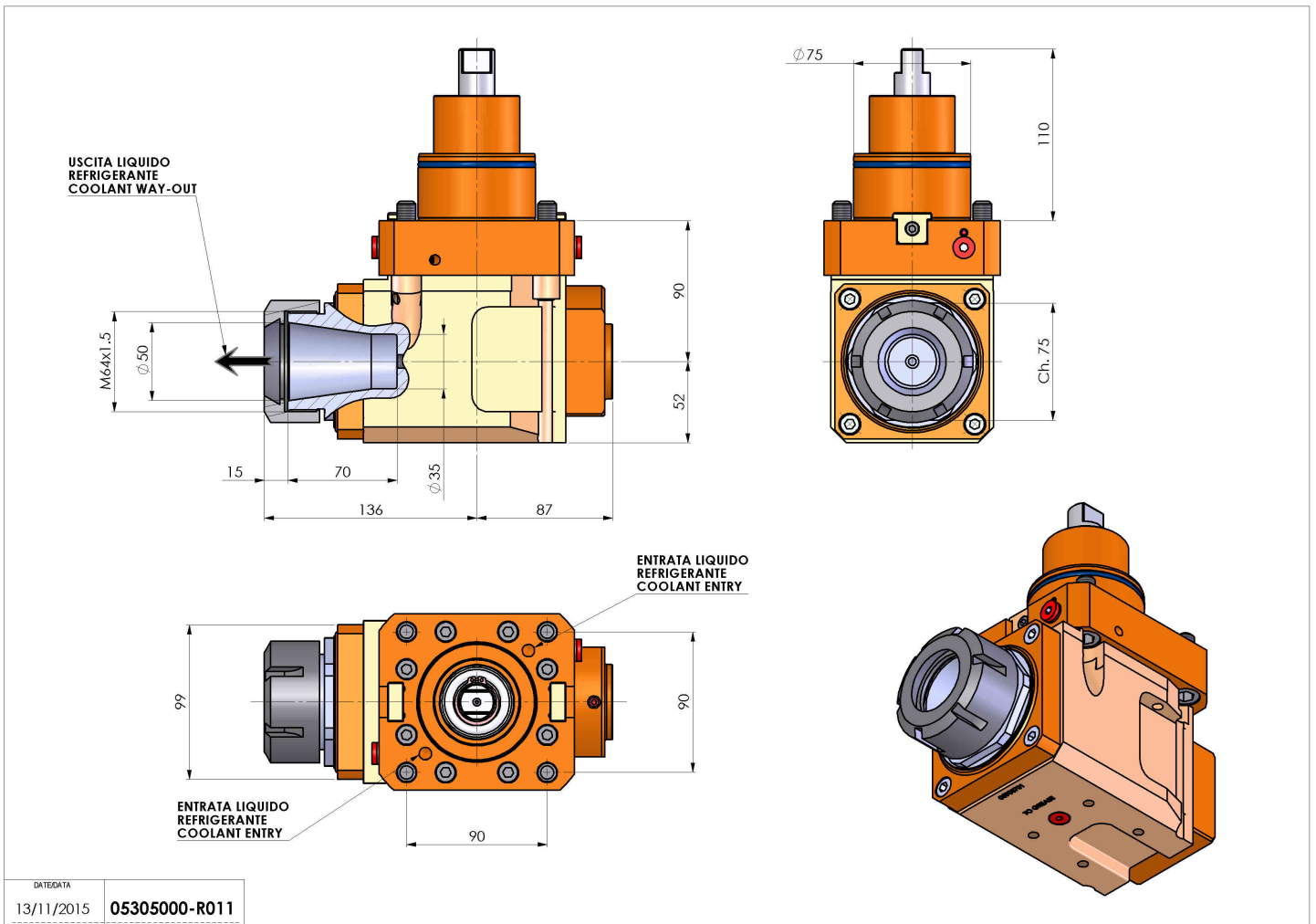

DATE/DATE	13/11/2015
	05305000-R011

Subject to technical changes